



ORGA-LINE for TANDEMBOX

Order specification

www.blum.com

 **blum**[®]





So many practical advantages

- 4 Ideas for practical kitchens
- 6 Product configurator
- 8 ORGA-LINE for drawers
- 18 ORGA-LINE for high fronted pull-outs
 - TANDEMBOX intivo
 - TANDEMBOX antaro
 - TANDEMBOX plus
- 24 ORGA-LINE kitchen accessories
- 26 Recommendation for pull-outs
- 30 Blum

DYNAMIC SPACE – Ideas for practical kitchens

blum

Space

Motion

Workflow

What makes kitchens practical?

Kitchens come in for heavy duty use so you soon find out what makes them practical. We have identified three key features of practical kitchens at Blum during the course of our research. Good workflows, optimal room utilisation and high ease of use or: In short, workflow, space and motion.

DYNAMIC SPACE delivers ideas for practical kitchens.

Well-designed products such as ORGA-LINE bring high functionality to every kitchen. Solutions such as the SPACE TOWER larder unit and the SPACE CORNER corner cabinet are optimised to the needs of kitchen users. Our experience and research data can provide helpful insight during the kitchen planning phase.

Be inspired!

➤ For more information about DYNAMIC SPACE go to:
www.blum.com/ideas

**DYNAMIC
SPACE**®

Ideas from Blum
for practical kitchens



Practical flexibility

ORGA-LINE containers, longside and cross dividers can be arranged as required depending on the item being stored. Whatever you need to store, ORGA-LINE provides practical organisation in your drawers and optimised storage space. There is even room for additional items such as pots or dishes, for example.



Practical overview

With ORGA-LINE, everything is stored where it can be seen, even larger items can be stored securely. An overview of everything: Individual items can be stored where they can be seen with good organisation thanks to ORGA-LINE. When your guests want to help out in the kitchen, the right spice quickly comes to hand.



Practical accessories

ORGA-LINE kitchen accessories simplify daily workflows, and provide organization and overview. Because with the foil dispenser, knife, spice and plate holders, everything is close to hand exactly where it's needed – whether in the kitchen or at a Barbecue. When the cooking is done, these small tools can be quickly stored away.



Practical clean-up

Children's sticky fingers leave their mark – we all know that. With ORGA-LINE, this is not a problem. The high-quality stainless steel containers are very easy to clean without marring the material – even in the dishwasher. That is Blum quality – for the lifetime of the furniture.

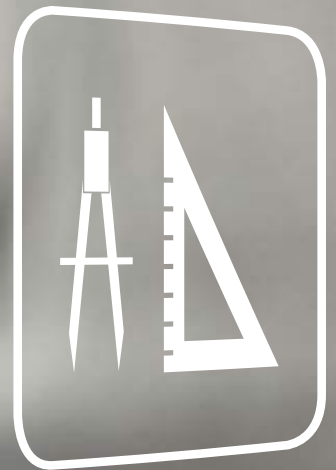
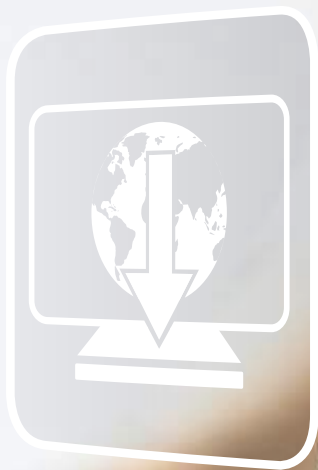

**Online configuration –
fast and simple**

Fast and simple

Online configuration



We support you with our online services to maintain an overview of ORGA-LINE and the associated kitchen accessories.

Using the web browser of your choice, you have access 24/7 to ORGA-LINE online for quick and easy personalised configuration options.



For drawers with utensil divides and containers



For pull-outs with longside and cross dividers



Enhanced by practical ORGA-LINE kitchen accessories

Selecting an ORGA-LINE system is very easy using the Product configurator. All you have to do is select the product line and enter the drawer dimensions to get a suggestion for your interior organisational system.

Your advantages at a glance:

- Intuitive interface – quick and easy
- Online availability 24/7
- Product solutions and assembly information that are always up-to-date
- Correct, error-free results – tested by Blum



➤ More about the online product configurator:
www.blum.com/productconfigurator

ORGA-LINE for drawers



Overview of ORGA-LINE sets

Blum offers practical inner dividing systems for drawers for every type of storage item. ORGA-LINE sets with high quality stainless steel trays and/or utensil dividers are available in all nominal lengths from 450 to 650 mm. We have the right applications for any drawer width, providing excellent organisation and overview.



Flexible cutlery dividers

Cutlery and so much more stay perfectly organised in the high quality, hygienic stainless steel trays. The containers are removable and dishwasher safe.



Flexible utensil dividers

Storage items of every shape and size are a perfect fit for ORGA-LINE. The flexible utensil dividers can be arranged to fit your needs.



Combo sets

This combination of utensil dividers and containers are not just for the kitchen – you can use them throughout the entire house.

Practical expandability

ORGA-LINE for drawers



ORGA-LINE sets for drawers can be expanded with foil/film dispensers and a knife holder. Practical kitchen accessories ensure simple workflows and easy handling.



Individual foil/film dispenser

The foil or film dispenser fits perfectly in the narrow utensil divider for quick and easy access.

Foil/Film dispenser as a set

The wide utensil divider provides a perfect drawer location for both foil and film dispensers.

Knife holder

The knife holder is ideal for the wide utensil divider, providing practical storage for up to 9 knives.

ORGA-LINE kitchen accessories

Please see pages 16/17 for more information.

i Placement of kitchen accessories

1 1x ZSZ.01F0

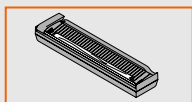

Or:
1 1x ZSZ.02F0

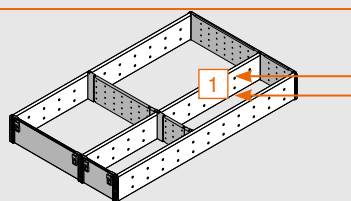
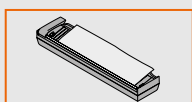

2 1x ZSZ.01F0 + 1x ZSZ.02F0

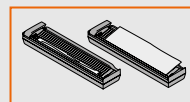

Or:
2 1x ZSZ.02M0

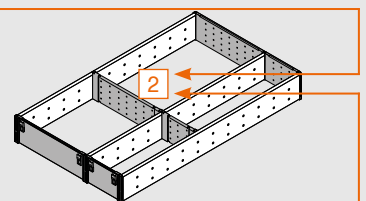
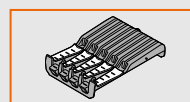

ORGA-LINE for drawers



Container sets

Description

- Container sets are especially practical for kitchen applications
- Well-suited for cutlery
- For drawers and inner drawers with cabinet widths 275 to 1200 mm
- Available in all nominal lengths from 450 to 650 mm
- Removable containers – dishwasher proof
- Can be combined with a film/foil dispenser or knife holder

Order specification

Space requirement

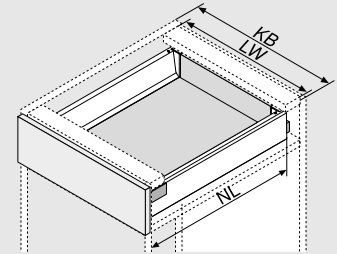

KB	Cabinet width
LW	Inner cabinet width
NL	Nominal length

Cabinet widths 275–299 mm



NL	Part No.
450 mm	ZSI.450B11N
500 mm	ZSI.500B11N
550 mm	ZSI.550B11N
600 mm	ZSI.600B11N
650 mm	ZSI.650B11N

Cabinet widths 300–399 mm



NL	Part No.
450 mm	ZSI.450B12N
500 mm	ZSI.500B12N
550 mm	ZSI.550B12N
600 mm	ZSI.600B12N
650 mm	ZSI.650B12N

Cabinet width 400–549 mm



NL	Part No.
450 mm	ZSI.450B13N
500 mm	ZSI.500B13
550 mm	ZSI.550B13
600 mm	ZSI.600B13
650 mm	ZSI.650B13

Cabinet widths 550–599 mm



NL	Part No.
450 mm	ZSI.450B11N + ZSI.450B13N
500 mm	ZSI.500B11N + ZSI.500B13
550 mm	ZSI.550B11N + ZSI.550B13
600 mm	ZSI.600B11N + ZSI.600B13
650 mm	ZSI.650B11N + ZSI.650B13

Cabinet width 600 mm



NL	Part No.
450 mm	ZSI.60VEI4
500 mm	ZSI.60VEI6
550 mm	ZSI.60VEI7
600 mm	ZSI.600B11N + ZSI.600B13
650 mm	ZSI.650B11N + ZSI.650B13

Cabinet widths 601–699 mm



NL	Part No.
450 mm	ZSI.450B11N + ZSI.450B13N
500 mm	ZSI.500B11N + ZSI.500B13
550 mm	ZSI.550B11N + ZSI.550B13
600 mm	ZSI.600B11N + ZSI.600B13
650 mm	ZSI.650B11N + ZSI.650B13

Cabinet width 700–799 mm



NL	Part No.
450 mm	ZSI.450B12N + ZSI.450B13N
500 mm	ZSI.500B12N + ZSI.500B13
550 mm	ZSI.550B12N + ZSI.550B13
600 mm	ZSI.600B12N + ZSI.600B13
650 mm	ZSI.650B12N + ZSI.650B13

Cabinet widths 800–899 mm



NL	Part No.
450 mm	2 x ZSI.450B13N
500 mm	2 x ZSI.500B13
550 mm	2 x ZSI.550B13
600 mm	2 x ZSI.600B13
650 mm	2 x ZSI.650B13

Cabinet width 900 mm



NL	Part No.
450 mm	ZSI.90VEI4
500 mm	ZSI.90VEI6
550 mm	ZSI.90VEI7
600 mm	ZSI.600B13 + ZSI.600K14
650 mm	ZSI.650B13 + ZSI.650K14

◀ Set fully fills drawer



Cabinet widths 901–999 mm



NL	Part No.
450 mm	ZSI.450BI3N + ZSI.450KI4N
500 mm	ZSI.500BI3 + ZSI.500KI4
550 mm	ZSI.550BI3 + ZSI.550KI4
600 mm	ZSI.600BI3 + ZSI.600KI4
650 mm	ZSI.650BI3 + ZSI.650KI4

Cabinet widths 1000–1099 mm





NL	Part No.
450 mm	2 x ZSI.450KI4N
500 mm	2 x ZSI.500KI4
550 mm	2 x ZSI.550KI4
600 mm	2 x ZSI.600KI4
650 mm	2 x ZSI.650KI4

Cabinet widths 1100–1199 mm



NL	Part No.
450 mm	2x ZSI.450BI3N + ZSI.450FI2N
500 mm	2x ZSI.500BI3 + ZSI.500FI2N
550 mm	2x ZSI.550BI3 + ZSI.550FI2N
600 mm	2x ZSI.600BI3 + ZSI.600FI2N
650 mm	2x ZSI.650BI3 + ZSI.650FI2N

Cabinet width 1200 mm 



NL	Part No.
450 mm	ZSI.12VEI4
500 mm	ZSI.12VEI6
550 mm	ZSI.12VEI7
600 mm	2x ZSI.600BI3 + ZSI.600FI2N
650 mm	2x ZSI.650BI3 + ZSI.650FI2N

SPACE CORNER



NL	Part No.
600 mm	ZSI.450BI3E
650 mm	ZSI.500BI3E

1 2 Please see pages 16/17 for more information about the knife holder and foil/film dispenser.

ORGA-LINE for drawers



Utensil divider sets

Description

- Utensil divider sets are practical for kitchen applications as well as other areas of the home
- For drawers and inner drawers with cabinet widths 275 to 1200 mm
- Available in all nominal lengths from 450 to 650 mm
- Removable containers – dishwasher proof
- Can be combined with a film/foil dispenser or knife holder

Order specification

Space requirement

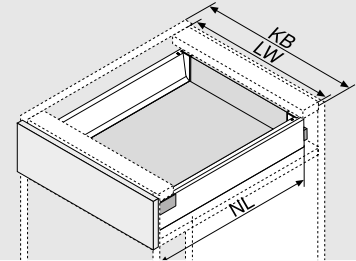

KB	Cabinet width
LW	Inner cabinet width
NL	Nominal length

Cabinet widths 275–349 mm



NL	Part No.
450 mm	ZSI.450B11N
500 mm	ZSI.500B11N
550 mm	ZSI.550B11N
600 mm	ZSI.600B11N
650 mm	ZSI.650B11N

Cabinet widths 350–449 mm



NL	Part No.
450 mm	ZSI.450K12N
500 mm	ZSI.500K12N
550 mm	ZSI.550K12N
600 mm	ZSI.600K12N
650 mm	ZSI.650K12N

Cabinet widths 450–599 mm



NL	Part No.
450 mm	ZSI.450F12N
500 mm	ZSI.500F12N
550 mm	ZSI.550F12N
600 mm	ZSI.600F12N
650 mm	ZSI.650F12N

Cabinet width 600 mm



NL	Part No.
450 mm	ZSI.60VUI4
500 mm	ZSI.60VUI6
550 mm	ZSI.60VUI7
600 mm	ZSI.600B11N + ZSI.600K13N
650 mm	ZSI.650B11N + ZSI.650K13N

Cabinet widths 601–699 mm



NL	Part No.
450 mm	ZSI.450B11N + ZSI.450K13N
500 mm	ZSI.500B11N + ZSI.500K13N
550 mm	ZSI.550B11N + ZSI.550K13N
600 mm	ZSI.600B11N + ZSI.600K13N
650 mm	ZSI.650B11N + ZSI.650K13N

Cabinet widths 700–799 mm



NL	Part No.
450 mm	ZSI.450K12N + ZSI.450K13N
500 mm	ZSI.500K12N + ZSI.500K13N
550 mm	ZSI.550K12N + ZSI.550K13N
600 mm	ZSI.600K12N + ZSI.600K13N
650 mm	ZSI.650K12N + ZSI.650K13N

Cabinet width 800–899 mm



NL	Part No.
450 mm	2x ZSI.450K13N
500 mm	2x ZSI.500K13N
550 mm	2x ZSI.550K13N
600 mm	2x ZSI.600K13N
650 mm	2x ZSI.650K13N

Cabinet width 900 mm



NL	Part No.
450 mm	ZSI.90VUI4
500 mm	ZSI.90VUI6
550 mm	ZSI.90VUI7
600 mm	2x ZSI.600K13N
650 mm	2x ZSI.650K13N

◀ Set fully fills drawer



Cabinet widths 901–999 mm



NL	Part No.
450 mm	2x ZSI.450KI3N
500 mm	2x ZSI.500KI3N
550 mm	2x ZSI.550KI3N
600 mm	2x ZSI.600KI3N
650 mm	2x ZSI.650KI3N

Cabinet widths 1000–1099 mm



NL	Part No.
450 mm	2x ZSI.450KI2N + ZSI.450FI3
500 mm	2x ZSI.500KI2N + ZSI.500FI3
550 mm	2x ZSI.550KI2N + ZSI.550FI3
600 mm	2x ZSI.600KI2N + ZSI.600FI3
650 mm	2x ZSI.650KI2N + ZSI.650FI3

Cabinet widths 1100–1199 mm



NL	Part No.
450 mm	2x ZSI.450KI3N + ZSI.450FI2N
500 mm	2x ZSI.500KI3N + ZSI.500FI2N
550 mm	2x ZSI.550KI3N + ZSI.550FI2N
600 mm	2x ZSI.600KI3N + ZSI.600FI2N
650 mm	2x ZSI.650KI3N + ZSI.600FI2N

Cabinet width 1200 mm 

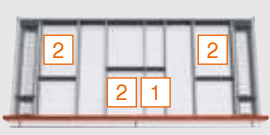

NL	Part No.
450 mm	ZSI.12VUI4
500 mm	ZSI.12VUI6
550 mm	ZSI.12VUI7
600 mm	2x ZSI.600KI3N + ZSI.600FI3
650 mm	2x ZSI.650KI3N + ZSI.650FI3

SPACE CORNER



NL	Part No.
600 mm	ZSI.450FI3
650 mm	ZSI.500FI3

1 **2** Please see pages 16/17 for more information about the knife holder and foil/film dispenser.

ORGA-LINE for drawers



Combo sets

Description

- Combinations of utensil dividers and containers are well-suited for the kitchen and the living area
- For drawers and inner drawers with cabinet widths 275 to 1200 mm
- Available in all nominal lengths from 450 to 650 mm
- Removable containers – dishwasher proof
- Can be combined with a film/foil dispenser or knife holder

Order specification

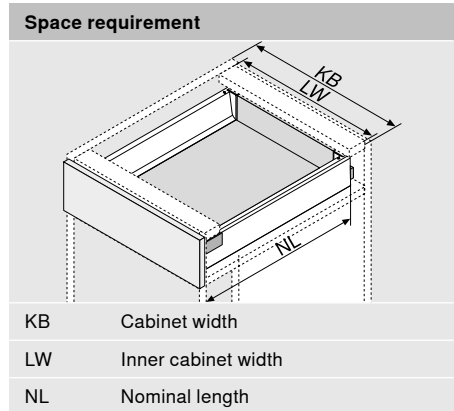

Cabinet widths 275–349 mm

NL	Part No.
450 mm	ZSI.450B11N
500 mm	ZSI.500B11N
550 mm	ZSI.550B11N
600 mm	ZSI.600B11N
650 mm	ZSI.650B11N

Cabinet widths 350–449 mm

NL	Part No.
450 mm	ZSI.450K12N
500 mm	ZSI.500K12N
550 mm	ZSI.550K12N
600 mm	ZSI.600K12N
650 mm	ZSI.650K12N

Cabinet widths 450–600 mm

NL	Part No.
450 mm	ZSI.450MI3
500 mm	ZSI.500MI3
550 mm	ZSI.550MI3
600 mm	ZSI.600MI3
650 mm	ZSI.650MI3

Cabinet width 601–649 mm

NL	Part No.
450 mm	ZSI.450B11N + ZSI.450MI3
500 mm	ZSI.500B11N + ZSI.500MI3
550 mm	ZSI.550B11N + ZSI.550MI3
600 mm	ZSI.600B11N + ZSI.600MI3
650 mm	ZSI.650B11N + ZSI.650MI3

Cabinet width 650–750 mm

NL	Part No.
450 mm	ZSI.450K12N + ZSI.450MI3
500 mm	ZSI.500K12N + ZSI.500MI3
550 mm	ZSI.550K12N + ZSI.550MI3
600 mm	ZSI.600K12N + ZSI.600MI3
650 mm	ZSI.650K12N + ZSI.650MI3

Cabinet widths 751–899 mm

NL	Part No.
450 mm	ZSI.450KI3N + ZSI.450B13N
500 mm	ZSI.500KI3N + ZSI.500B13
550 mm	ZSI.550KI3N + ZSI.550B13
600 mm	ZSI.600KI3N + ZSI.600B13
650 mm	ZSI.650KI3N + ZSI.650B13

Cabinet widths 900–1200 mm

NL	Part No.
450 mm	ZSI.450KI3N + ZSI.450K14N
500 mm	ZSI.500KI3N + ZSI.500K14
550 mm	ZSI.550KI3N + ZSI.550K14
600 mm	ZSI.600KI3N + ZSI.600K14
650 mm	ZSI.650KI3N + ZSI.650K14

SPACE CORNER

NL	Part No.
600 mm	ZSI.450F13
650 mm	ZSI.500F13

1 2 Please see pages 16/17 for more information about the knife holder and foil/film dispenser.



ORGA-LINE for drawers

blum

ORGA-LINE for drawers



Individual sets

Description

- These flexible, modular sets are well-suited for applications in the kitchen as well as other living areas
- For drawers and inner drawers in different cabinet widths
- Available in all nominal lengths from 450 to 650 mm
- Sets include utensil divides, container sets or a combination of the two
- Removable containers – dishwasher proof
- Can be combined with a film/foil dispenser or knife holder

Order specification

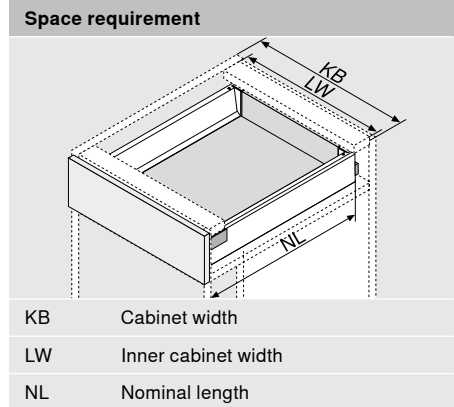

Set BI1

NL	Part No.
450 mm	ZSI.450BI1N
500 mm	ZSI.500BI1N
550 mm	ZSI.550BI1N
600 mm	ZSI.600BI1N
650 mm	ZSI.650BI1N

Set BI2

NL	Part No.
450 mm	ZSI.450BI2N
500 mm	ZSI.500BI2N
550 mm	ZSI.550BI2N
600 mm	ZSI.600BI2N
650 mm	ZSI.650BI2N

Set BI3

NL	Part No.
450 mm	ZSI.450BI3N
500 mm	ZSI.500BI3
550 mm	ZSI.550BI3
600 mm	ZSI.600BI3
650 mm	ZSI.650BI3

Set KI2

NL	Part No.
450 mm	ZSI.450KI2N
500 mm	ZSI.500KI2N
550 mm	ZSI.550KI2N
600 mm	ZSI.600KI2N
650 mm	ZSI.650KI2N

Set KI3

NL	Part No.
450 mm	ZSI.450KI3N
500 mm	ZSI.500KI3N
550 mm	ZSI.550KI3N
600 mm	ZSI.600KI3N
650 mm	ZSI.650KI3N

Set KI4

NL	Part No.
450 mm	ZSI.450KI4N
500 mm	ZSI.500KI4
550 mm	ZSI.550KI4
600 mm	ZSI.600KI4
650 mm	ZSI.650KI4

Set MI3

NL	Part No.
450 mm	ZSI.450MI3
500 mm	ZSI.500MI3
550 mm	ZSI.550MI3
600 mm	ZSI.600MI3
650 mm	ZSI.650MI3

Individual sets

ORGA-LINE for drawers



Set FI1

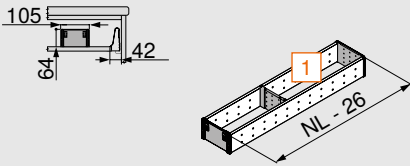

NL	Part No.
450 mm	ZSI.450FI1
500 mm	ZSI.500FI1
550 mm	ZSI.550FI1
600 mm	ZSI.600FI1
650 mm	ZSI.650FI1

Set FI2

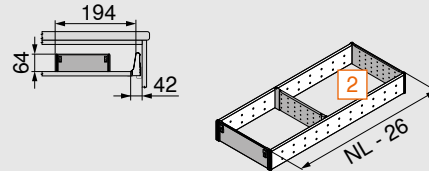

NL	Part No.
450 mm	ZSI.450FI2N
500 mm	ZSI.500FI2N
550 mm	ZSI.550FI2N
600 mm	ZSI.600FI2N
650 mm	ZSI.650FI2N

Set FI3

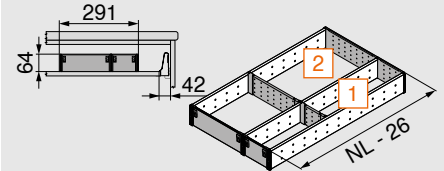

NL	Part No.
450 mm	ZSI.450FI3
500 mm	ZSI.500FI3
550 mm	ZSI.550FI3
600 mm	ZSI.600FI3
650 mm	ZSI.650FI3

Set BI3E for SPACE CORNER

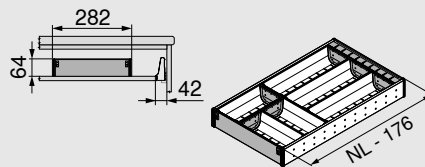

NL	Part No.
600 mm	ZSI.450BI3E
650 mm	ZSI.500BI3E

Adjustable cross dividers

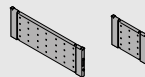

Width	Part No.
88 mm	ZSI.010Q
176 mm	ZSI.020Q

Containers

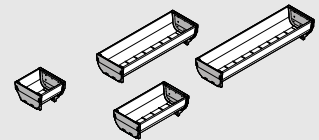

Size	Part No.
88 x 88 mm	ZSI.010SI
88 x 176 mm	ZSI.020SI
88 x 264 mm	ZSI.030SI
88 x 352 mm	ZSI.040SI

Foil/Film dispenser

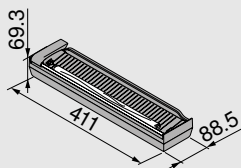

For plastic film	Part No.
incl. film	ZSZ.01F0
without film	ZSZ.01F1

- 1 1x ZSZ.01F0
- 2 1x ZSZ.01F0 + 1x ZSZ.02F0

Foil/Film dispenser

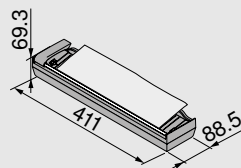

For aluminium foil	Part No.
incl. foil	ZSZ.02F0
without foil	ZSZ.02F1

- 1 1x ZSZ.01F0
- 2 1x ZSZ.01F0 + 1x ZSZ.02F0

Knife holder

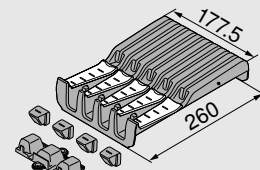

For 9 knives	Part No.
	ZSZ.02M0

- 2 1x ZSZ.02M0

i Placement of kitchen accessories

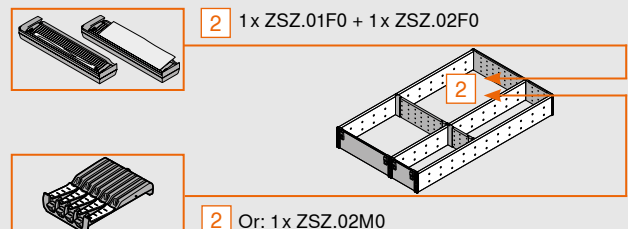
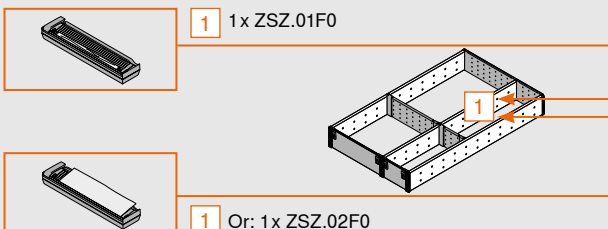

**ORGA-LINE for drawers –
TANDEMBOX intivo**



Silk white



Terra black



Order specification

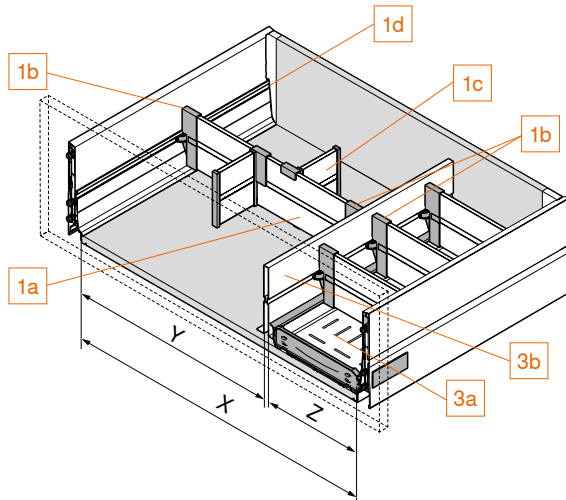

1a Cross divider for cutting to size

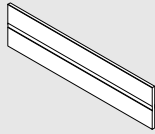

KB	Part No.
275 mm	Z40L152A
300 mm	Z40L177A
550 mm	Z40L427A
600 mm	Z40L477A
900 mm	Z40L777A
1200 mm	Z40L1077A

Silk white, terra black

Alu for cutting to size

Cutting:

X = LW - 91 mm

Y = LW - 295 (KB 275) Y = LW - 320 mm (KB 300)

Z = 152 mm (KB 275) Z = 177 mm (KB 300)

1b Cross divider connector



Part No.	
Silk white, terra black	Z40L0002

1c Longside divider

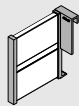

Part No.	
Silk white, terra black	Z43L100S

1d Adapter profile for cross divider

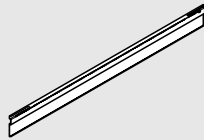

NL	Part No.
270 mm 2x	Z49L242S
300 mm 2x	Z49L272S
350 mm 2x	Z49L322S
400 mm 2x	Z49L372S
450 mm 2x	Z49L422S
500 mm 2x	Z49L472S
550 mm 2x	Z49L522S
600 mm 2x	Z49L572S
650 mm 2x	Z49L622S

Silk white, terra black

3a Bottle rack

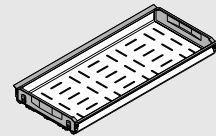

NL	Part No.	Part No.
450 mm		Z48.30B014
500 mm	Z48.27B016	Z48.30B016
550 mm	Z48.27B017	Z48.30B017
600 mm	Z48.27B018	Z48.30B018
650 mm	Z48.27B019	Z48.30B019
	KB 275 mm	KB 300 mm

3b Dividing wall

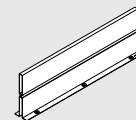

Not available for the inner pull-out

NL	Part No.
450 mm	Z46L420S
500 mm	Z46L470S
550 mm	Z46L520S
600 mm	Z46L570S
650 mm	Z46L620S

Silk white, terra black

KB	Cabinet width
LW	Inner cabinet width
NL	Nominal length

ORGA-LINE for drawers – TANDEMBOX antaro

blum®



Cross divider, height C



Cross divider, height D



Cross gallery

TANDEMBOX antaro

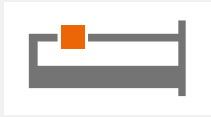

ORGA-LINE for drawers



Order specification

1a Cross divider for cutting to size

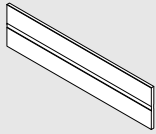

KB	Part No.
275 mm	Z40L152A
300 mm	Z40L177A
550 mm	Z40L427A
600 mm	Z40L477A
900 mm	Z40L777A
1200 mm	Z40L1077A

Silk white, terra black, RAL 9006

Alu for cutting to size

Cutting:	X = LW - 91 mm
Y = LW - 295 (KB 275)	Y = LW - 320 mm (KB 300)
Z = 152 mm (KB 275)	Z = 177 mm (KB 300)

1b Cross divider connector



For gallery	Part No.
For height C	Z40C0002Z
For height D	Z40D0002Z

Silk white, terra black, white grey

1c Cross divider connector



For dividing wall	Part No.
	Z40L0002

Silk white, terra black, white grey

1d Longside divider

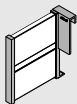

Silk white, terra black, RAL 9006	Part No.
	Z43L100S

Cross divider

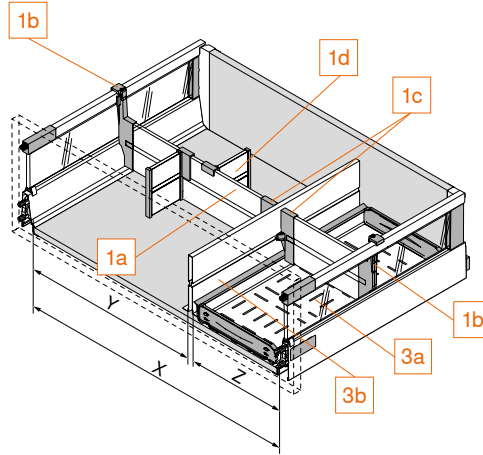

2a Cross gallery for cutting to size

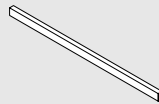

KB	Part No.
275 mm	ZRG.179Q
300 mm	ZRG.204Q
550 mm	ZRG.454Q
600 mm	ZRG.504Q
900 mm	ZRG.804Q
1200 mm	ZRG.1104Q

Silk white, terra black, RAL 9006

Alu for cutting to size

Cutting: LW - 63 mm

2b Cross gallery connector



Silk white, terra black, white grey	Part No.
	ZRU.01E0

2c Longside divider for cross gallery



Silk white, terra black, white grey	Part No.
	ZRU.11F0

Cross gallery

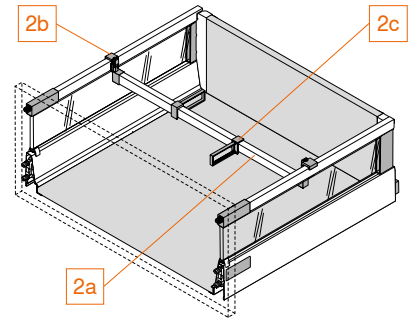

i The cross gallery cannot be used in combination with a dividing wall.

3a Bottle rack

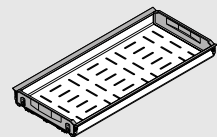

NL	Part No.	Part No.
450 mm		Z48.30B014
500 mm	Z48.27B016	Z48.30B016
550 mm	Z48.27B017	Z48.30B017
600 mm	Z48.27B018	Z48.30B018
650 mm	Z48.27B019	Z48.30B019
	KB 275 mm	KB 300 mm

3b Dividing wall

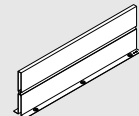

Not available for the inner pull-out

NL	Part No.
450 mm	Z46L420S
500 mm	Z46L470S
550 mm	Z46L520S
600 mm	Z46L570S
650 mm	Z46L620S

Silk white, terra black, RAL 9006

KB Cabinet width

LW Inner cabinet width

NL Nominal length

ORGA-LINE for drawers – TANDEMBOX plus

blum



Cross divider for BOXSIDE



Cross divider for gallery



Cross gallery

TANDEMBOX plus

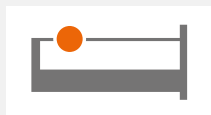



ORGA-LINE for drawers

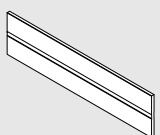

Order specification

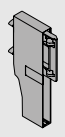
1a Cross divider for cutting to size	
	
KB	Part No.
275 mm	Z40L152A
300 mm	Z40L177A
550 mm	Z40L427A
600 mm	Z40L477A
900 mm	Z40L777A
1200 mm	Z40L1077A
Silk white, RAL 9006	
Alu for cutting to size	
Cutting:	
X = LW - 91 mm	
Y = LW - 295 (KB 275)	Y = LW - 320 mm (KB 300)
Z = 152 mm (KB 275)	Z = 177 mm (KB 300)

1b Cross divider connector	
	
	Part No.
For BOXSIDE, dividing wall	Z40H0002Z
RAL 7037 dust grey	

1c Cross divider connector	
	
	Part No.
For gallery	Z40H0002ZR
RAL 7037 dust grey	

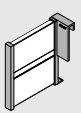
1d Longside divider	
	
	Part No.
Steel	Z43L100S
Silk white, RAL 9006	

Cross divider for BOXSIDE

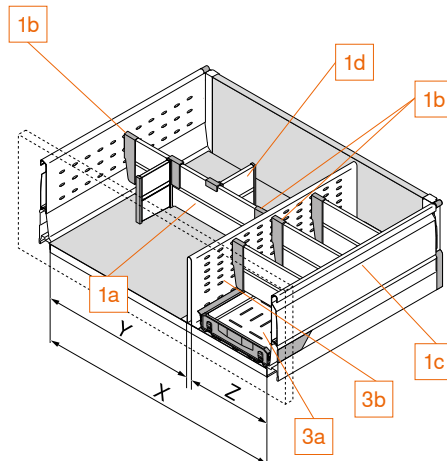

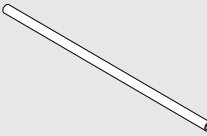
2a Cross gallery for cutting to size	
	
	Part No.
KB up to 1200 mm	ZRG.1094U
White, RAL 9006	
Alu for cutting to size	
Cutting: LW - 68 mm	

2b Cross gallery connector	
	
	Part No.
RAL 7037 dust grey	ZRU.0020

2c Longside divider for cross gallery	
	
	Part No.
RAL 7037 dust grey	ZRU.00F0

Cross gallery

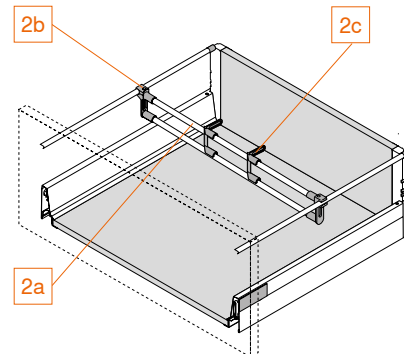

The cross gallery cannot be used in combination with a dividing wall.

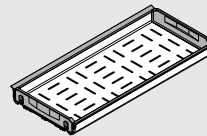
3a Bottle rack		
		
NL	Part No.	Part No.
450 mm		Z48.30B014
500 mm	Z48.27B016	Z48.30B016
550 mm	Z48.27B017	Z48.30B017
600 mm	Z48.27B018	Z48.30B018
650 mm	Z48.27B019	Z48.30B019
	KB 275 mm	KB 300 mm

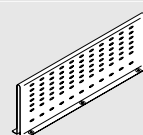
3b Dividing wall	
	
Not available for the inner pull-out	
NL	Part No.
450 mm	Z46C420S.E2
500 mm	Z46C470S.E2
550 mm	Z46C520S.E2
600 mm	Z46C570S.E2
650 mm	Z46C620S.E2
White, RAL 9006	

KB	Cabinet width
LW	Inner cabinet width
NL	Nominal length

ORGA-LINE kitchen accessories

blum



Description

- Foil/Film dispenser for crease-free sheets
- Knife holder for safe storage of knives in the drawer
- Plate holder for easy transport and secure storage in the pull-out
- Spice holder for storage and easy access to spice containers of all sizes
- Also available in the practical complete set



Order specification

Knife holder	
For 9 knives	Part No. ZSZ.02M0

Foil/Film dispenser	
For plastic film	Part No.
incl. film	ZSZ.01F0
without film	ZSZ.01F1

Foil/Film dispenser	
For aluminium foil	Part No.
incl. foil	ZSZ.02F0
without foil	ZSZ.02F1

Spice holder	
KB	Part No.
300 mm (width 212 mm)	ZFZ.30G01
400 mm (width 312 mm)	ZFZ.40G01
450 mm (width 362 mm)	ZFZ.45G01
KB	Cabinet width

Plate-holder	
	Part No.
Ø plates 186–322 mm	ZC7T0350
Total height 170 mm	
Stacking height: up to 12 plates	

Kitchen tool set	
	Part No.
Set	ZOU.30U11
Includes:	
1 x knife holder	
1 x film dispenser (incl. film)	
1 x foil dispenser (incl. foil)	
2 x spice holders (for KB 300 mm)	
2 x plate holders	



**ORGA-LINE for TANDEMBOX –
Recommendation for pull-outs**

Recommendation for pull-outs

ORGA-LINE for TANDEMBOX



Recommendation for spices

NL	KB (mm)		
	300	400	450
450 mm	1 x QT, 2 x GH		1 x QT
500 mm			2 x LT, 2 x GH
550 mm			
600 mm	2 x QT, 2 x GH		2 x QT, 3 x LT
650 mm			2 x GH

Recommendation for pots, lids and cooking utensils

NL	KB (mm)				
	600	800	900	1000	1200
450 mm	1 x QT, 2 x LT	1 x QT, 3 x LT			
500 mm	2 x QT, 6 x LT				
550 mm					
600 mm					
650 mm					



Recommendation for provisions and open provisions

NL	KB (mm)										
	275	300	400	450	500	550	600	800	900	1000	1200
450 mm	1 x QT		1 x QT, 2 x LT				1 x QT, 3 x LT				
500 mm	2 x QT										
550 mm											
600 mm											
650 mm											

SPACE CORNER

600 mm	1 x QT, 2 x LT										
650 mm	1 x QT, 2 x LT										

Recommendation for plastic containers

NL	KB (mm)										
	275	300	400	450	500	550	600	800	900	1000	1200
450 mm	2 x QT										
500 mm											
550 mm											
600 mm											
650 mm	1 x QT		1 x QT, 2 x LT				1 x QT, 3 x LT				

SPACE CORNER

600 mm	1 x QT, 2 x LT										
650 mm	1 x QT, 2 x LT										

ORGA-LINE for TANDEMBOX



Recommendation for pull-outs



Recommendation for bottles

NL	KB (mm)	
	275	300
450 mm		3 x QT, 1 x FW
500 mm	4 x QT, 1 x FW	
550 mm	4 x QT, 1 x FW	
600 mm	5 x QT, 1 x FW	
650 mm	5 x QT, 1 x FW	

Recommendation for recycling/ waste separation and cleaning agents

NL	KB (mm)	
	900 and higher	
450 mm	3 x QT, 1 x FW, 2 x ZW	
500 mm	4 x QT, 1 x FW, 2 x ZW	
550 mm	4 x QT, 1 x FW, 2 x ZW	
600 mm	5 x QT, 1 x FW, 2 x ZW	
650 mm	5 x QT, 1 x FW, 2 x ZW	



Recommendation for bottles and cutting boards

NL	KB (mm)								
	400	450	500	550	600	800	900	1000	1200
450 mm	3 x QT, 1 x FW, 1 x ZW			3 x QT, 1 x FW, 2 x ZW					
500 mm	4 x QT, 1 x FW, 1 x ZW			4 x QT, 1 x FW, 2 x ZW					
550 mm	4 x QT, 1 x FW, 1 x ZW			4 x QT, 1 x FW, 2 x ZW					
600 mm	5 x QT, 1 x FW, 1 x ZW			5 x QT, 1 x FW, 2 x ZW					
650 mm	5 x QT, 1 x FW, 1 x ZW			5 x QT, 1 x FW, 2 x ZW					

Recommendation for baking trays and tins

NL	KB (mm)			
	300	400	450	500 and higher
450 mm				
500 mm				
550 mm	1 x ZW	2 x ZW		3 x ZW
600 mm				
650 mm				

FW	Bottle rack	KB	Cabinet width	NL	Nominal length	TH	Plate holder
GH	Spice holder	LT	Longside divider	QT	Cross divider	ZW	Dividing wall

Recommendation for pull-outs

ORGA-LINE for TANDEMBOX



Recommended for plates

NL	KB (mm)		
	400 a. higher	800 and higher	1000 and higher
450 mm	2 x TH	4 x TH	6 x TH
500 mm			
550 mm			
600 mm			
650 mm			

SPACE CORNER

	KB (mm)	
	up to 1050	1050 and higher
	2 x TH	3 x TH

FW	Bottle rack	KB	Cabinet width
GH	Spice holder	LT	Longside divider

The company Blum

Founded over 60 years ago by Julius Blum, Blum is a family-owned company that operates on an international scale. Its strategic business segments include lift, hinge and pull-out systems. All our product developments focus on perfecting motion.

www.blum.com

The Blum logo consists of a white upward-pointing arrowhead to the left of the word "blum" in a lowercase, bold, sans-serif font. The entire logo is set against a red background.



Blum in Austria and around the world

The company has eight plants in Vorarlberg, Austria, additional production sites in Poland, the USA and Brazil and 31 subsidiaries/representative offices. Blum supplies more than 120 markets. The Blum Group employs 8,000 people in total, 6,000 of whom work in Vorarlberg.



Global customer benefits

“Whether manufacturer, distributor, fitter or kitchen user – everybody should personally enjoy the benefits of Blum products” – that is Blum’s philosophy on global customer benefits.



Innovations

To support customers with innovative fittings solutions and secure long-term success for the company, we need to consistently invest in research and development, in plants and facilities and in employee training. With more than 2,100 granted patents worldwide, Blum is one of Austria’s most innovative companies.



Quality

Blum’s comprehensive concept of quality does not only apply to products. Services and collaboration with customers and partners should also meet the same quality requirements.



Environment

At Blum, we believe that responsible ecological behaviour has long-term economic benefits. The longevity of products is just one of many important aspects. Other important measures include the use of environmentally-friendly processes, the intelligent use of materials and prudent energy management.



DYNAMIC SPACE

Good workflows, optimum use of storage space and top quality motion are important features of a practical kitchen. Blum’s ideas for practical kitchens are designed to bring function, convenience and ergonomics to furniture interiors.



Julius Blum GmbH
Furniture Fittings Mfg.
6973 Höchst, Austria
Tel.: +43 5578 705-0
Fax: +43 5578 705-44
E-mail: info@blum.com
www.blum.com

