

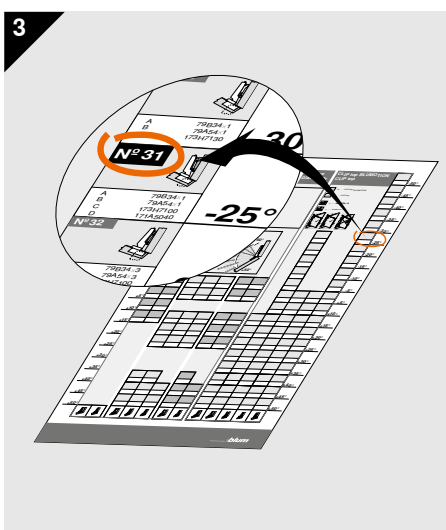

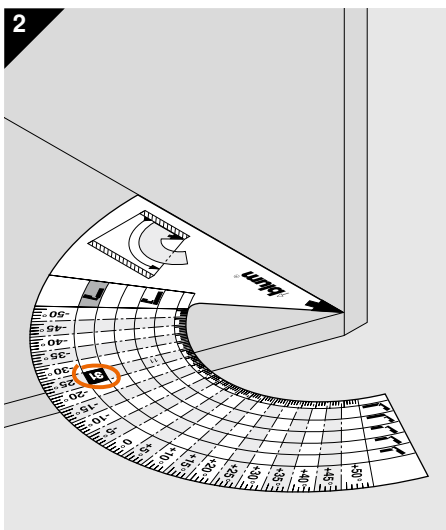

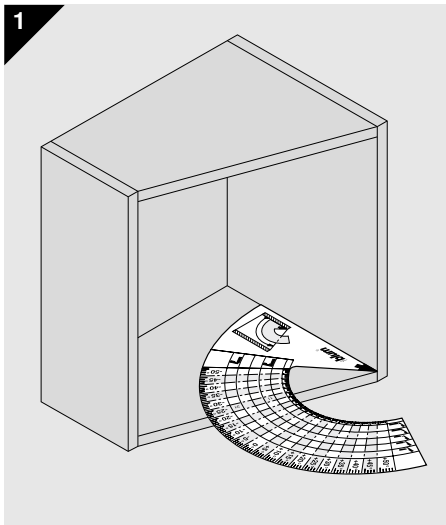











PYTHAGORAS









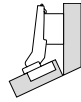
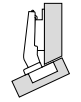











































PYTHAGORAS

65.5810.02

-50°										<p>N° 26</p>  <ul style="list-style-type: none"> A 79B34:0 B 78A5450.T C 173H7100 D 171A5500
-45°										<p>N° 27</p>  <ul style="list-style-type: none"> A 79B34:0 B 78A5450.T C 173H7130
-40°										<p>N° 28</p>  <ul style="list-style-type: none"> A 79B34:0 B 78A5450.T C 173H7100 D 171A5040
-35°										<p>N° 29</p>  <ul style="list-style-type: none"> A 79B34:1 B 78A5451.T C 173H7100 D 171A5500
-30°										<p>N° 30</p>  <ul style="list-style-type: none"> A 79B34:1 B 78A5451.T C 173H7130
-25°										<p>N° 31</p>  <ul style="list-style-type: none"> A 79B34:1 B 78A5451.T C 173H7100 D 171A5040
-20°										<p>N° 32</p>  <ul style="list-style-type: none"> A 79B34:3 B 78A5453.T C 173H7100 D 171A5500
-15°										<p>N° 33</p>  <ul style="list-style-type: none"> A 79B34:3 B 78A5453.T C 173H7100
-10°										<p>N° 34</p>  <ul style="list-style-type: none"> A 79B34:3 B 78A5453.T C 173H7100 D 171A5010
-5°										<p>N° 35</p>  <ul style="list-style-type: none"> A 71B95:0 B 70T9550.TL C 173H7100 D 171A5500
										<p>N° 11</p>  <ul style="list-style-type: none"> A 79B34:1 B 78A5451.T C 175H7190 D 171A5070
										<p>N° 12</p>  <ul style="list-style-type: none"> A 79B34:3 B 78A5453.T C 175H9160 D 171A5500
										<p>N° 13</p>  <ul style="list-style-type: none"> A 79B34:3 B 78A5453.T C 175H7190.22
										<p>N° 14</p>  <ul style="list-style-type: none"> A 79B34:3 B 78A5453.T C 175H7190 D 171A5070
										<p>N° 15</p>  <ul style="list-style-type: none"> A 71B95:0 B 70T9650.TL C 173H7100 D 171A5500
										
										

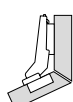
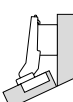
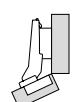
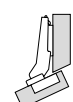
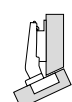
	N° 16  A 71B97.0 B 70T950.TL C 173H7100 D 171A5010	N° 46  A 71B96.0 B 70T9650.TL C 173H7100 D 171A5070	N° 1  A 71B95.0 B 70T9550.TL C 173H7100 D 171A5010	N° 36  A 71B95.0 B 70T9550.TL C 173H7100 D 171A5010	+5°
	N° 17  A 79B94.4 B 78A9454.T C 175H7190.22 D 171A5500	N° 47  A 79B94.4 B 78A9454.T C 175H7190.22 D 171A5500	N° 2  A 79B94.4 B 78A9454.T C 173H7100 D 171A5500	N° 37  A 79B94.4 B 78A9454.T C 173H7100 D 171A5500	+10°
N° 55  A 79B95.5 B 78A9555.T C 173H7100 D 171A5500	N° 18  A 79B95.5 B 78A9555.T C 175H7190 D 171A5500	N° 48  A 79B95.5 B 78A9555.T C 173H7130 D 171A5500	N° 3  A 79B94.4 B 78A9454.T C 175H7190	N° 38  A 79B94.4 B 78A9454.T C 175H9160	+15°
N° 56  A 79B95.5 B 78A9555.T C 175H9160	N° 19  A 79B95.5 B 78A9555.T C 175H7190.22	N° 49  A 79B95.5 B 78A9555.T C 175H7190	N° 4  A 79B95.5 B 78A9555.T C 173H7100	N° 39  A 79B94.4 B 78A9454.T C 173H7100 D 171A5070	+20°
N° 57  A 79B95.6 B 78A9556.T C 173H7100 D 171A5500	N° 20  A 79B95.6 B 78A9556.T C 175H7190 D 171A5500	N° 50  A 79B95.6 B 78A9556.T C 173H7100 D 171A5500	N° 5  A 79B95.5 B 78A9555.T C 173H7100 D 171A5010	N° 40  A 79B94.6 B 78A9456.T C 173H7100 D 171A5500	+25°
N° 58  A 79B95.6 B 78A9556.T C 173H7130	N° 21  A 79B95.6 B 78A9556.T C 175H7190.22	N° 51  A 79B95.6 B 78A9556.T C 175H7190	N° 6  A 79B95.6 B 78A9556.T C 173H7100	N° 41  A 79B94.6 B 78A9456.T C 175H9160	+30°
N° 59  A 79B95.6 B 78A9556.T C 173H7100 D 171A5040	N° 22  A 79B95.6 B 78A9556.T C 175H7190.22 D 171A5010	N° 52  A 79B95.6 B 78A9556.T C 173H7100 D 171A5070	N° 7  A 79B95.6 B 78A9556.T C 173H7100 D 171A5010	N° 42  A 79B94.6 B 78A9456.T C 173H7100 D 171A5070	+35°
N° 109  A 79B94.8 B 78A9458.T C 175H7190 D 171A5010	N° 23  A 79B96.8 B 78A9558.T C 175H7190 D 171A5500	N° 108  A 79B94.8 B 78A9458.T C 175H7190 D 171A5040	N° 8  A 79B94.8 B 78A9458.T C 175H9160 D 171A5500	N° 43  A 79B94.8 B 78A9458.T C 173H7100 D 171A5500	+40°
N° 60  A 79B96.8 B 78A9658.T C 173H7100	N° 24  A 79B35.8 B 78T5550 C 175H7190.22	N° 53  A 79B96.8 B 78A9658.T C 173H7100	N° 9  A 79B35.8 B 78T5550 C 173H7100	N° 44  A 79B94.8 B 78A9458.T C 175H9160	+45°
N° 61  A 79B96.8 B 78A9658.T C 173H7100 D 171A5010	N° 25  A 79B96.8 B 78A9658.T C 175H7190 D 171A5070	N° 54  A 79B96.8 B 78A9658.T C 173H7100 D 171A5010	N° 10  A 79B35.8 B 78T5550 C 173H7100 D 171A5010	N° 45  A 79B94.8 B 78A9458.T C 173H7100 D 171A5070	+50°
					

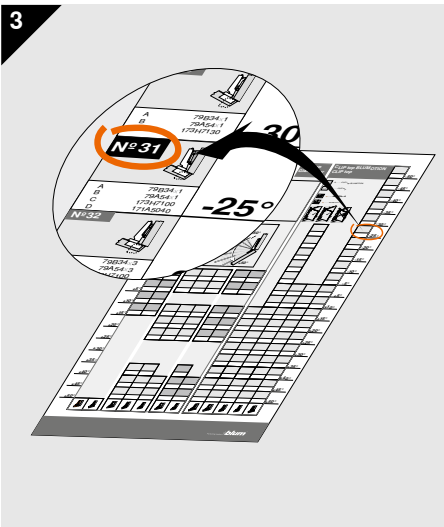
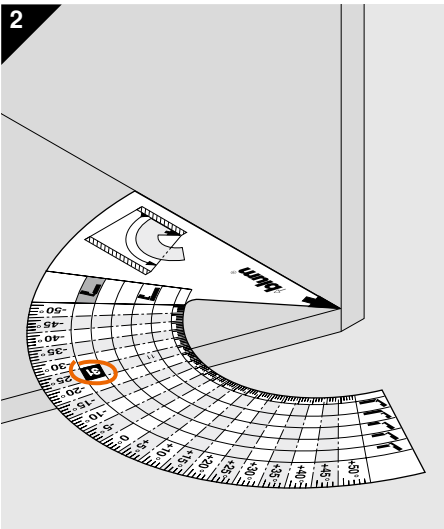
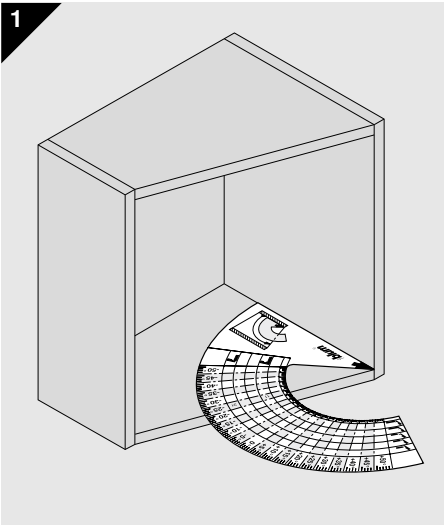

	<table border="1"> <tr> <th>N° 106</th> <th>N° 107</th> </tr> <tr> <td></td> <td></td> </tr> <tr> <td>A' 71B4500C</td> <td>A' 71B4500C</td> </tr> <tr> <td>B' 70T4500CTL</td> <td>B' 70T4500CTL</td> </tr> <tr> <td>C 173H7100</td> <td>C 173H7100</td> </tr> <tr> <td>D 171A5500</td> <td>D 171A5500</td> </tr> </table>	N° 106	N° 107			A' 71B4500C	A' 71B4500C	B' 70T4500CTL	B' 70T4500CTL	C 173H7100	C 173H7100	D 171A5500	D 171A5500	<table border="1"> <tr> <th>N° 114</th> <th>N° 110</th> </tr> <tr> <td></td> <td></td> </tr> <tr> <td>A 71B453T</td> <td>A 71B453T</td> </tr> <tr> <td>B 70T453T.TL</td> <td>B 70T453T.TL</td> </tr> <tr> <td>C 173H7100</td> <td>C 173H7100</td> </tr> <tr> <td>D 171A5500</td> <td>D 171A5500</td> </tr> </table>	N° 114	N° 110			A 71B453T	A 71B453T	B 70T453T.TL	B 70T453T.TL	C 173H7100	C 173H7100	D 171A5500	D 171A5500
N° 106	N° 107																									
A' 71B4500C	A' 71B4500C																									
B' 70T4500CTL	B' 70T4500CTL																									
C 173H7100	C 173H7100																									
D 171A5500	D 171A5500																									
N° 114	N° 110																									
A 71B453T	A 71B453T																									
B 70T453T.TL	B 70T453T.TL																									
C 173H7100	C 173H7100																									
D 171A5500	D 171A5500																									
-5°	<table border="1"> <tr> <th>N° 103</th> <th>N° 100</th> </tr> <tr> <td></td> <td></td> </tr> <tr> <td>A' 71B4500C</td> <td>A' 71B4500C</td> </tr> <tr> <td>B' 70T4500CTL</td> <td>B' 70T4500CTL</td> </tr> <tr> <td>C 173H7100</td> <td>C 173H7100</td> </tr> <tr> <td>D 171A5010</td> <td>D 171A5010</td> </tr> </table>	N° 103	N° 100			A' 71B4500C	A' 71B4500C	B' 70T4500CTL	B' 70T4500CTL	C 173H7100	C 173H7100	D 171A5010	D 171A5010	<table border="1"> <tr> <th>N° 115</th> <th>N° 111</th> </tr> <tr> <td></td> <td></td> </tr> <tr> <td>A 71B453T</td> <td>A 71B453T</td> </tr> <tr> <td>B 70T453T.TL</td> <td>B 70T453T.TL</td> </tr> <tr> <td>C 173H7100</td> <td>C 173H7100</td> </tr> <tr> <td>D 171A5010</td> <td>D 171A5010</td> </tr> </table>	N° 115	N° 111			A 71B453T	A 71B453T	B 70T453T.TL	B 70T453T.TL	C 173H7100	C 173H7100	D 171A5010	D 171A5010
N° 103	N° 100																									
A' 71B4500C	A' 71B4500C																									
B' 70T4500CTL	B' 70T4500CTL																									
C 173H7100	C 173H7100																									
D 171A5010	D 171A5010																									
N° 115	N° 111																									
A 71B453T	A 71B453T																									
B 70T453T.TL	B 70T453T.TL																									
C 173H7100	C 173H7100																									
D 171A5010	D 171A5010																									
+5°	<table border="1"> <tr> <th>N° 104</th> <th>N° 101</th> </tr> <tr> <td></td> <td></td> </tr> <tr> <td>A' 71B4500C</td> <td>A' 71B4500C</td> </tr> <tr> <td>B' 70T4500CTL</td> <td>B' 70T4500CTL</td> </tr> <tr> <td>C 173H7100</td> <td>C 173H7100</td> </tr> <tr> <td>D (2x) 171A5010</td> <td>D (2x) 171A5010</td> </tr> </table>	N° 104	N° 101			A' 71B4500C	A' 71B4500C	B' 70T4500CTL	B' 70T4500CTL	C 173H7100	C 173H7100	D (2x) 171A5010	D (2x) 171A5010	<table border="1"> <tr> <th>N° 116</th> <th>N° 112</th> </tr> <tr> <td></td> <td></td> </tr> <tr> <td>A 71B453T</td> <td>A 71B453T</td> </tr> <tr> <td>B 70T453T.TL</td> <td>B 70T453T.TL</td> </tr> <tr> <td>C 173H7100</td> <td>C 173H7100</td> </tr> <tr> <td>D (2x) 171A5010</td> <td>D (2x) 171A5010</td> </tr> </table>	N° 116	N° 112			A 71B453T	A 71B453T	B 70T453T.TL	B 70T453T.TL	C 173H7100	C 173H7100	D (2x) 171A5010	D (2x) 171A5010
N° 104	N° 101																									
A' 71B4500C	A' 71B4500C																									
B' 70T4500CTL	B' 70T4500CTL																									
C 173H7100	C 173H7100																									
D (2x) 171A5010	D (2x) 171A5010																									
N° 116	N° 112																									
A 71B453T	A 71B453T																									
B 70T453T.TL	B 70T453T.TL																									
C 173H7100	C 173H7100																									
D (2x) 171A5010	D (2x) 171A5010																									
+10°	<table border="1"> <tr> <th>N° 105</th> <th>N° 102</th> </tr> <tr> <td></td> <td></td> </tr> <tr> <td>A' 71B4500C</td> <td>A' 71B4500C</td> </tr> <tr> <td>B' 70T4500CTL</td> <td>B' 70T4500CTL</td> </tr> <tr> <td>C 173H7100</td> <td>C 173H7100</td> </tr> <tr> <td>D (3x) 171A5010</td> <td>D (3x) 171A5010</td> </tr> </table>	N° 105	N° 102			A' 71B4500C	A' 71B4500C	B' 70T4500CTL	B' 70T4500CTL	C 173H7100	C 173H7100	D (3x) 171A5010	D (3x) 171A5010	<table border="1"> <tr> <th>N° 117</th> <th>N° 113</th> </tr> <tr> <td></td> <td></td> </tr> <tr> <td>A 71B453T</td> <td>A 71B453T</td> </tr> <tr> <td>B 70T453T.TL</td> <td>B 70T453T.TL</td> </tr> <tr> <td>C 173H7100</td> <td>C 173H7100</td> </tr> <tr> <td>D (3x) 171A5010</td> <td>D (3x) 171A5010</td> </tr> </table>	N° 117	N° 113			A 71B453T	A 71B453T	B 70T453T.TL	B 70T453T.TL	C 173H7100	C 173H7100	D (3x) 171A5010	D (3x) 171A5010
N° 105	N° 102																									
A' 71B4500C	A' 71B4500C																									
B' 70T4500CTL	B' 70T4500CTL																									
C 173H7100	C 173H7100																									
D (3x) 171A5010	D (3x) 171A5010																									
N° 117	N° 113																									
A 71B453T	A 71B453T																									
B 70T453T.TL	B 70T453T.TL																									
C 173H7100	C 173H7100																									
D (3x) 171A5010	D (3x) 171A5010																									
+15°	<p>Zur Befestigung des Scharniers an die Front wird zusätzlich die CRISTALLO-Topplatte benötigt:</p> <p>*The CRISTALLO adhesion plate is also necessary to fix the hinge to the front:</p> <p>*Pour fixer la charnière sur la face, il est nécessaire d'ajouter la semelle de boîtier CRISTALLO :</p> <p>*Per fissare la cerniera al frontale occorre in aggiunta il portafondello CRISTALLO:</p> <p>*Para la fijación de la bisagra en el frente se requiere adicionalmente la placa de cazoleta CRISTALLO:</p> <div style="display: flex; align-items: center;"> 70T4568C </div>																									

— Standard
standard
standard
standard
estándar

— CRISTALLO

— Dünne Türen
Thin doors
Portes minces
Ante sottili
Puertas delgadas



A CLIP top BLUMOTION



B CLIP top ohne Feder
CLIP top unsprung
CLIP top sans ressort
CLIP top senza molla
CLIP top sin muelle



x INSERTA = 9



x Schrauben = 5
screw-on
à visser
viti
por atornillado

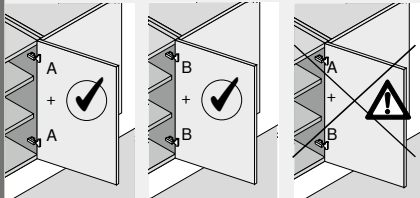

C Montageplatte
Mounting plate
Embase
Piastrina di premontaggio
Base



D Winkelkeil
Angled spacer
Cale d'angle
Cuneo ad angolo
Cuña de ángulo

Julius Blum GmbH
6973 Höchst, Austria
Tel.: +43 5578 705-0
Fax: +43 5578 705-44
E-mail: info@blum.com
www.blum.com

Our sites in Austria, Poland and China are certified to the international standards mentioned below.
Our site in the USA is certified to ISO 9001.
Our site in Brazil is certified to ISO 9001, ISO 14001 and ISO 45001.



ISO 9001
Certified Quality
System



ISO 14001
Certified Environmental
System



ISO 50001
Certified Energy
System

 **blum**®



Look for our
FSC™-certified
products

All content is copyrighted by Blum.
Subject to technical modifications and changes to the range without notice.
IDNR: 519.138.2 · FO-163/1 EN-AL/02.25