



blum®

Perfecting motion



Blum Produkte erkennen



Wer sich für Produkte von Blum entscheidet, darf hohe Bewegungsqualität erwarten – ein Möbelleben lang. Jedes Produkt wird ausgiebig und nach strengen Kriterien geprüft. Um sicherzustellen, dass Blum Produkte verwendet werden, bieten wir mit diesem Dokument eine Hilfestellung, die aufzeigt wie Sie ein echtes Blum Produkt erkennen können.





Klappensysteme ▶



Scharniersysteme ▶



Boxsysteme ▶



Führungssysteme ▶



Inneneinteilungssysteme ▶



SERVO-DRIVE ▶

AVENTOS HF



AVENTOS HS



AVENTOS HL



AVENTOS HK



AVENTOS HK-S





AVENTOS HF



AVENTOS HS



AVENTOS HL



AVENTOS HK



AVENTOS HK-S



CLIP

CLIP top

CLIP top BLUMOTION



MODUL



Montageplatten

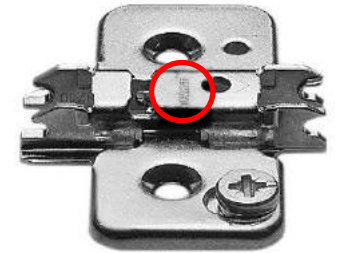
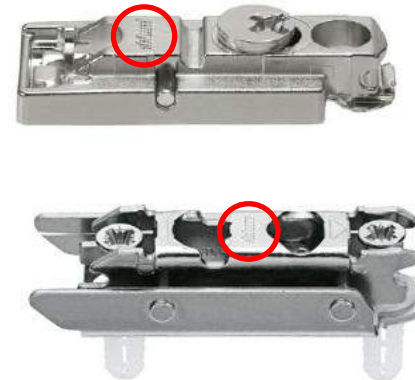

BLUMOTION

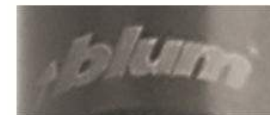
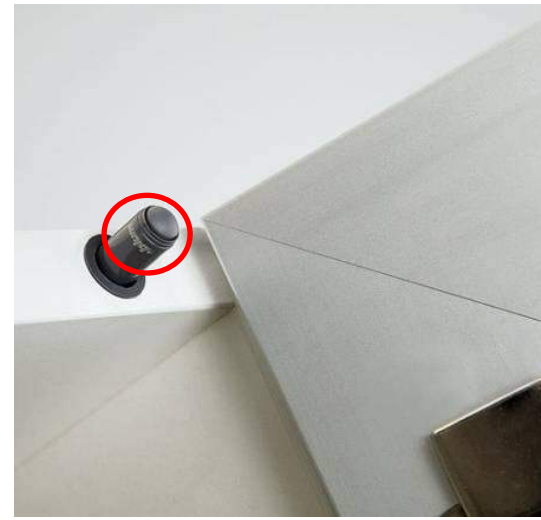

TIP-ON



Boxsysteme

3



TANDEMBOX intivo
TANDEMBOX antaro
TANDEMBOX plus

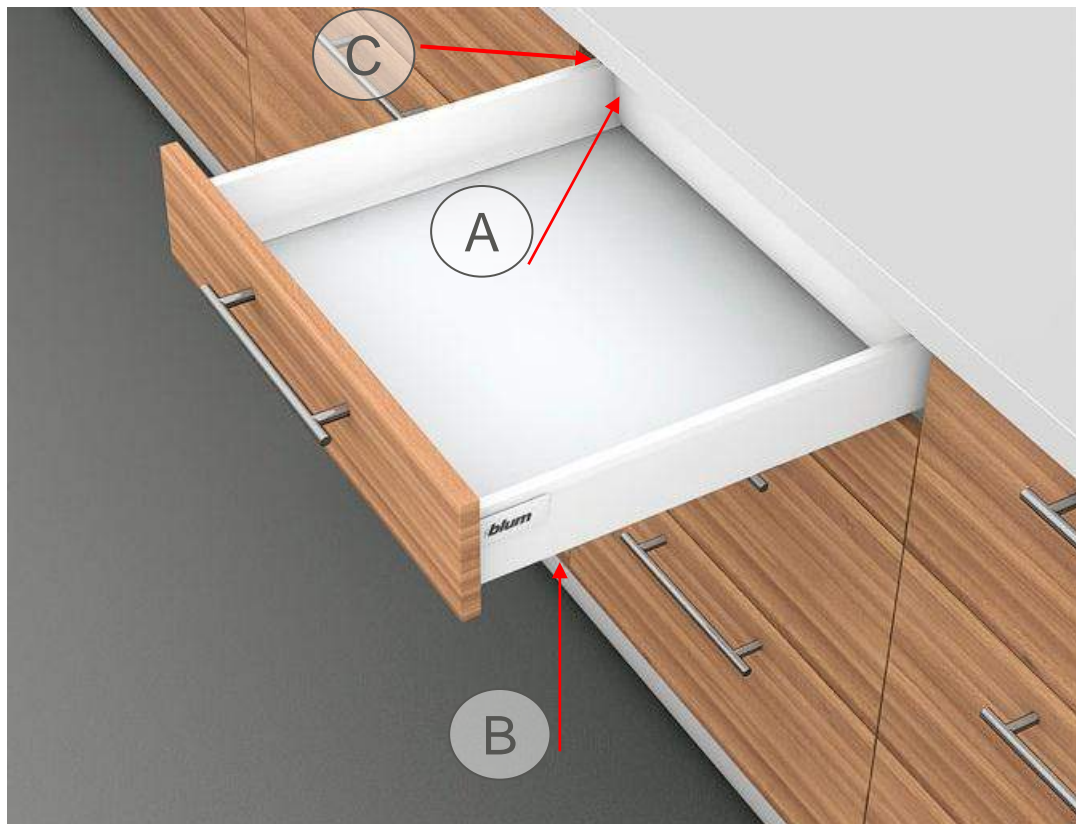

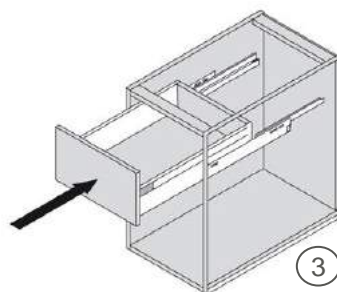
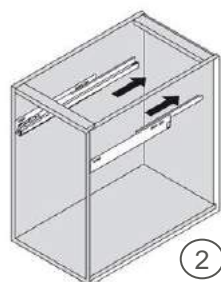
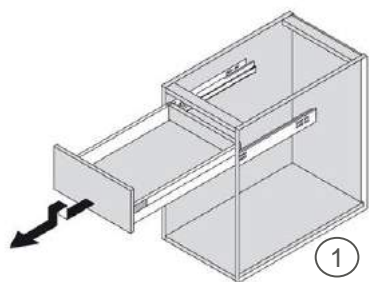

METABOX





MOVENTO /
TANDEM



TANDEM





MOVENTO



TANDEM





MOVENTO

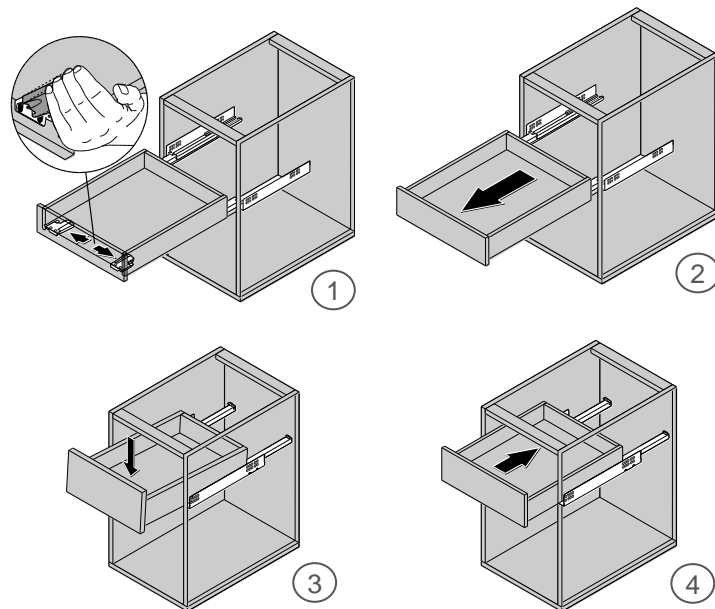

TANDEM





TANDEM

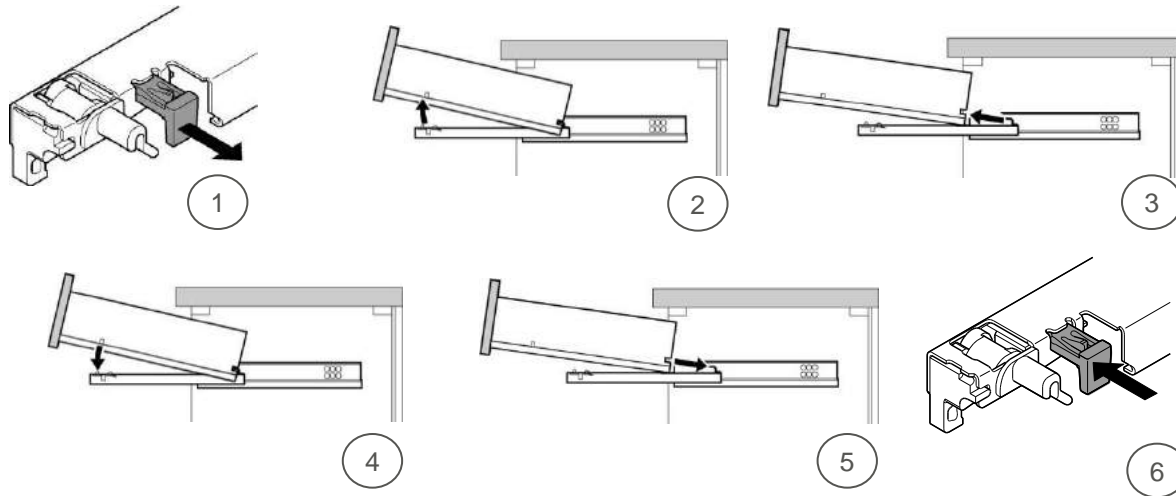

TANDEMBOX intivo

TANDEMBOX antaro

TANDEMBOX plus

TANDEMBOX intivo
TANDEMBOX antaro
TANDEMBOX plus

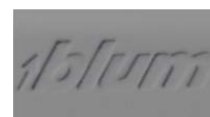
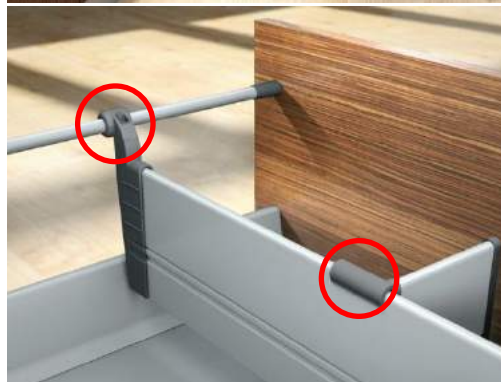
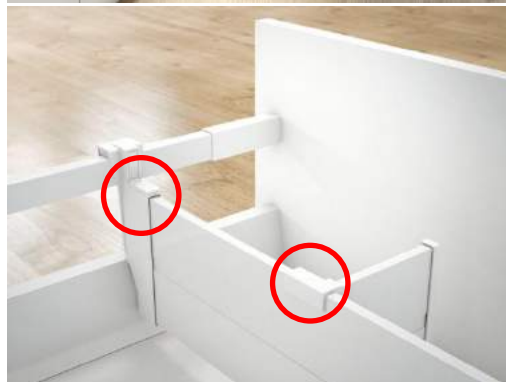
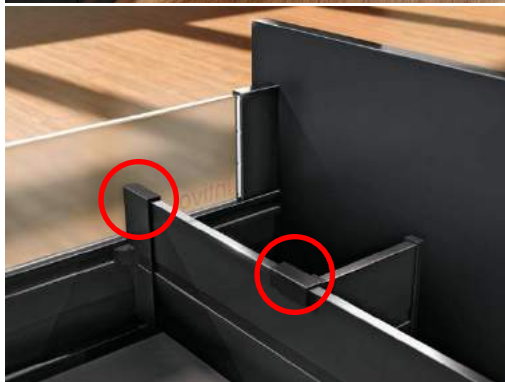

ORGA-LINE Küchenhelfer



SERVO-DRIVE

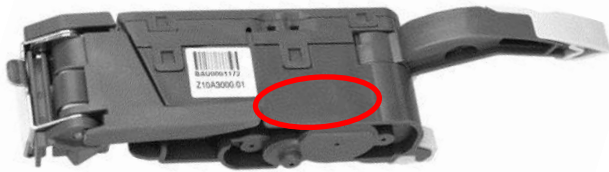

SERVO-DRIVE uno

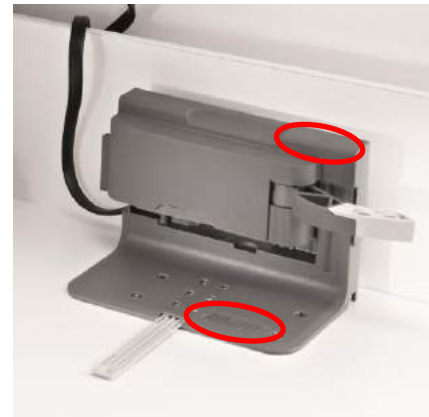

SERVO-DRIVE für AVENTOS





blum®

Perfecting motion