



ORGA-LINE for TANDEMBOX

www.blum.com

 **blum**[®]

Contents

- 4 Ideas for practical homes
- 6 Product Configurator
- 8 Overview of ORGA-LINE sets
- 10 ORGA-LINE for drawers
- 18 ORGA-LINE for pull-outs
- 20 Recommendation for pull-outs
- 22 ORGA-LINE kitchen accessories



Many practical advantages



What inspires you?

Discover exciting ideas for more quality of living throughout your home.

www.blum-inspirations.com

Blum's practical solutions for your home

Kitchens that are fit for everyday use are not only beautiful but also practical.

They have the following features:

- Efficient workflow (ergonomics)
- Optimum space utilisation (storage space)
- Enhanced convenience (motion)
- Freedom for your ideas (design)

Blum Inspirations offers ideas for practical solutions. Well-designed products such as ORGA-LINE or clever cabinet solutions such as the SPACE TOWER larder unit or the SPACE CORNER cabinet bring functionality to every kitchen. Blum's expertise can come in useful right from the planning stage.



Ergonomics

Everything is easy to access and clearly organised.



Storage space

Make full use of the storage space available.



Motion

It's easy to open and close furniture.



Design

Turn your creative ideas into reality.



Online configuration – quick and easy

Our online services will help you keep an overview of ORGA-LINE and matching kitchen accessories.

Use a web browser of your choice and access ORGA-LINE online 24/7 for quick and easy personalised configuration options.

Your advantages at a glance:

- Intuitive interface – quick and easy
- Online availability 24/7
- Product solutions and assembly information that are always up to date
- Correct, error-free results – tested by Blum

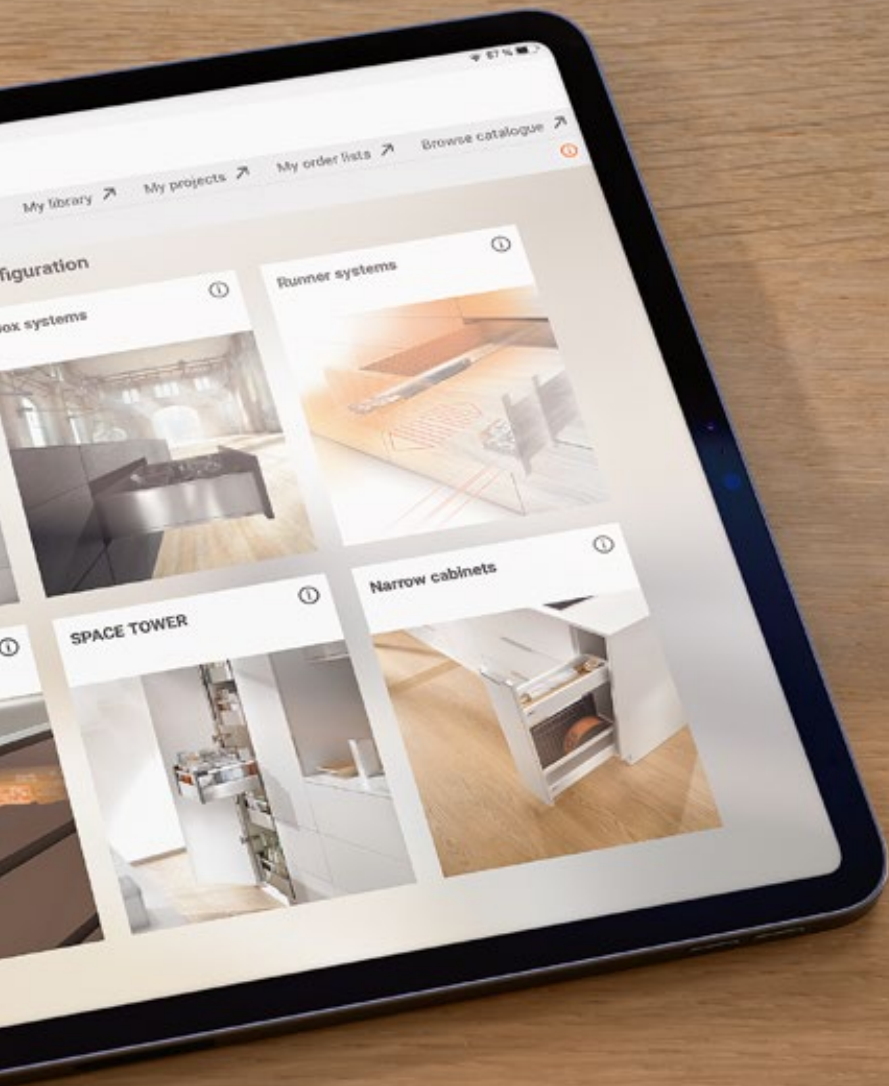

Find out more about the Product Configurator at:
www.blum.com/productconfigurator



For drawers with utensil dividers and containers



For pull-outs with lateral and cross dividers



Complemented by practical ORGA-LINE kitchen accessories

Overview of ORGA-LINE sets

Blum offers practical inner dividing systems for drawers for every type of storage item. ORGA-LINE sets with high-quality stainless steel trays and/or utensil dividers are available in all nominal lengths from 450 to 650 mm. We have the right applications for any drawer width so that you can beautifully organise interiors and effortlessly see every single item.



Practical dividers

High-quality, hygienic stainless steel trays keep cutlery and other items nice and tidy. The containers can be removed individually and are dishwasher safe.

Adjustable utensil dividers

ORGA-LINE allows you to beautifully organise storage items of every shape and size. The utensil dividers can be positioned flexibly to suit your needs.

Individual sets

Combine different sets and tailor interiors to meet your requirements.

Combo sets

These sets are a combination of utensil dividers and containers and are not only practical for kitchens, but for furniture throughout the home.





Practical flexibility

ORGA-LINE containers, lateral and cross dividers can be flexibly arranged to suit storage items. Whatever the contents, ORGA-LINE tidies up drawers and allows you to make full use of the storage space available. The system can be adapted at any time to accommodate more items, such as pots or dinnerware.



Practical visibility

ORGA-LINE gives you clear visibility of contents and ensures that large items are held securely. Everything at a glance: ORGA-LINE delivers organisation and easy access to every single item. And should guests want to help with the cooking, the right spice is immediately to hand.



Practical hygiene

Children's sticky fingers leave marks. Sounds familiar? No problem with ORGA-LINE. The high-quality stainless steel containers can be easily cleaned without damaging the material. They're even designed for dishwasher use. That is Blum quality – for the lifetime of the furniture.



Practical expandability

ORGA-LINE kitchen accessories make kitchen chores easier and organise interiors. The film/foil dispenser and knife, spice and plate holders ensure that everything is exactly where it should be – be it in the kitchen or at a garden buffet. And they can be quickly cleared away when you're done.

ORGA-LINE for drawers



Combo sets

Description

- These sets are a combination of utensil dividers and containers and are ideal for kitchens and living areas
- For drawers and inner drawers with cabinet widths 275 to 1200 mm
- Available in all nominal lengths from 450 to 550 mm
- Removable dishwasher-proof containers
- Can be combined with a film/foil dispenser or knife holder

Space requirement

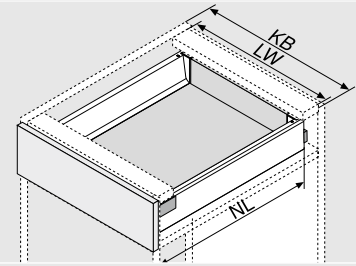

KB	Cabinet width
LW	Internal cabinet width
NL	Nominal length

Ordering information

Cabinet width 275 – 349 mm	
NL	Part no.
450 mm	ZSI.450BI1N
500 mm	ZSI.500BI1N
550 mm	ZSI.550BI1N

Cabinet width 350 – 449 mm	
NL	Part no.
450 mm	ZSI.450KI2N
500 mm	ZSI.500KI2N
550 mm	ZSI.550KI2N

Cabinet width 450 – 600 mm	
NL	Part no.
450 mm	ZSI.450MI3
500 mm	ZSI.500MI3
550 mm	ZSI.550MI3

Cabinet width 601 – 649 mm	
NL	Part no.
450 mm	ZSI.450BI1N + ZSI.450MI3
500 mm	ZSI.500BI1N + ZSI.500MI3
550 mm	ZSI.550BI1N + ZSI.550MI3

Cabinet width 650 – 750 mm	
NL	Part no.
450 mm	ZSI.450KI2N + ZSI.450MI3
500 mm	ZSI.500KI2N + ZSI.500MI3
550 mm	ZSI.550KI2N + ZSI.550MI3

Cabinet width 751 – 899 mm	
NL	Part no.
450 mm	ZSI.450KI3N + ZSI.450BI3N
500 mm	ZSI.500KI3N + ZSI.500BI3N
550 mm	ZSI.550KI3N + ZSI.550BI3N

Cabinet width 900 – 1200 mm	
NL	Part no.
450 mm	ZSI.450KI3N + ZSI.450KI4N
500 mm	ZSI.500KI3N + ZSI.500KI4
550 mm	ZSI.550KI3N + ZSI.550KI4

1 **2** Please see pages 22/23 for more information about the knife holder and film/foil dispenser.

Container sets

Description

- Container sets are especially practical for use in the kitchen
- Ideal for cutlery
- For drawers and inner drawers with cabinet widths 275 to 1200 mm
- Available in all nominal lengths from 450 to 550 mm
- Removable dishwasher-proof containers
- Can be combined with a film/foil dispenser or knife holder

Space requirement

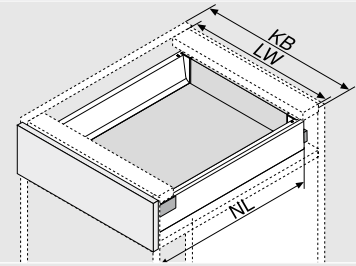

KB	Cabinet width
LW	Internal cabinet width
NL	Nominal length

Ordering information

Cabinet width 275 – 299 mm		Cabinet width 300 – 399 mm		Cabinet width 400 – 549 mm	
NL	Part no.	NL	Part no.	NL	Part no.
450 mm	ZSI.450BI1N	450 mm	ZSI.450BI2N	450 mm	ZSI.450BI3N
500 mm	ZSI.500BI1N	500 mm	ZSI.500BI2N	500 mm	ZSI.500BI3
550 mm	ZSI.550BI1N	550 mm	ZSI.550BI2N	550 mm	ZSI.550BI3
Cabinet width 550 – 599 mm		Cabinet width 600 mm		Cabinet width 601 – 699 mm	
NL	Part no.	NL	Part no.	NL	Part no.
450 mm	ZSI.450BI1N + ZSI.450BI3N	450 mm	ZSI.60VEI4	450 mm	ZSI.450BI1N + ZSI.450BI3N
500 mm	ZSI.500BI1N + ZSI.500BI3	500 mm	ZSI.60VEI6	500 mm	ZSI.500BI1N + ZSI.500BI3
550 mm	ZSI.550BI1N + ZSI.550BI3	550 mm	ZSI.60VEI7	550 mm	ZSI.550BI1N + ZSI.550BI3
Cabinet width 700 – 799 mm		Cabinet width 800 – 899 mm		Cabinet width 900 mm	
NL	Part no.	NL	Part no.	NL	Part no.
450 mm	ZSI.450BI2N + ZSI.450BI3N	450 mm	2 x ZSI.450BI3N	450 mm	ZSI.90VEI4
500 mm	ZSI.500BI2N + ZSI.500BI3	500 mm	2 x ZSI.500BI3	500 mm	ZSI.90VEI6
550 mm	ZSI.550BI2N + ZSI.550BI3	550 mm	2 x ZSI.550BI3	550 mm	ZSI.90VEI7



Cabinet width 901 – 999 mm



NL	Part no.
450 mm	ZSI.450BI3N + ZSI.450KI4N
500 mm	ZSI.500BI3 + ZSI.500KI4
550 mm	ZSI.550BI3 + ZSI.550KI4

Cabinet width 1000 – 1099 mm



NL	Part no.
450 mm	2x ZSI.450KI4N
500 mm	2x ZSI.500KI4
550 mm	2x ZSI.550KI4

Cabinet width 1100 – 1199 mm



NL	Part no.
450 mm	2x ZSI.450BI3N + ZSI.450FI2N
500 mm	2x ZSI.500BI3 + ZSI.500FI2N
550 mm	2x ZSI.550BI3 + ZSI.550FI2N

Cabinet width 1200 mm



NL	Part no.
450 mm	ZSI.12VEI4
500 mm	ZSI.12VEI6
550 mm	ZSI.12VEI7

1 **2** Please see pages 22/23 for more information about the knife holder and film/foil dispenser.

Utensil divider sets

Description

- Utensil divider sets are practical for use in the kitchen and in other areas of the home
- For drawers and inner drawers with cabinet widths 275 to 1200 mm
- Available in all nominal lengths from 450 to 550 mm
- Removable dishwasher-proof containers
- Can be combined with a film/foil dispenser or knife holder

Space requirement

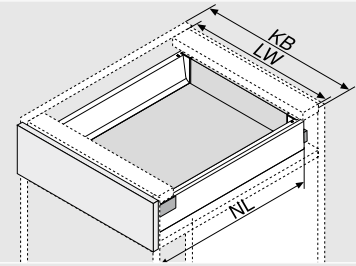

KB	Cabinet width
LW	Internal cabinet width
NL	Nominal length

Ordering information

Cabinet width 275–349 mm	
NL	Part no.
450 mm	ZSI.450BI1N
500 mm	ZSI.500BI1N
550 mm	ZSI.550BI1N

Cabinet width 350 – 449 mm	
NL	Part no.
450 mm	ZSI.450KI2N
500 mm	ZSI.500KI2N
550 mm	ZSI.550KI2N

Cabinet width 450 – 599 mm	
NL	Part no.
450 mm	ZSI.450FI2N
500 mm	ZSI.500FI2N
550 mm	ZSI.550FI2N

Cabinet width 600 mm	
NL	Part no.
450 mm	ZSI.60VUI4
500 mm	ZSI.60VUI6
550 mm	ZSI.60VUI7

Cabinet width 601 – 699 mm	
NL	Part no.
450 mm	ZSI.450BI1N + ZSI.450KI3N
500 mm	ZSI.500BI1N + ZSI.500KI3N
550 mm	ZSI.550BI1N + ZSI.550KI3N

Cabinet width 700 – 799 mm	
NL	Part no.
450 mm	ZSI.450KI2N + ZSI.450KI3N
500 mm	ZSI.500KI2N + ZSI.500KI3N
550 mm	ZSI.550KI2N + ZSI.550KI3N

Cabinet width 800 – 899 mm	
NL	Part no.
450 mm	2x ZSI.450KI3N
500 mm	2x ZSI.500KI3N
550 mm	2x ZSI.550KI3N

Cabinet width 900 mm	
NL	Part no.
450 mm	ZSI.90VUI4
500 mm	ZSI.90VUI6
550 mm	ZSI.90VUI7

◀ Set fills drawer



Cabinet width 901 – 999 mm



NL	Part no.
450 mm	2x ZSI.450KI3N
500 mm	2x ZSI.500KI3N
550 mm	2x ZSI.550KI3N

Cabinet width 1000 – 1099 mm



NL	Part no.
450 mm	2x ZSI.450KI2N + ZSI.450FI3
500 mm	2x ZSI.500KI2N + ZSI.500FI3
550 mm	2x ZSI.550KI2N + ZSI.550FI3

Cabinet width 1100 – 1199 mm



NL	Part no.
450 mm	2x ZSI.450KI3N + ZSI.450FI2N
500 mm	2x ZSI.500KI3N + ZSI.500FI2N
550 mm	2x ZSI.550KI3N + ZSI.550FI2N

Cabinet width 1200 mm



NL	Part no.
450 mm	ZSI.12VUI4
500 mm	ZSI.12VUI6
550 mm	ZSI.12VUI7

1 2 Please see pages 22/23 for more information about the knife holder and film/foil dispenser.

Individual sets

Description

- These flexible partial width sets are ideal for use in the kitchen and in other living areas
- For drawers and inner drawers in different cabinet widths
- Available in all nominal lengths from 450 to 550 mm
- Sets include utensil dividers, container sets or a combination of the two
- Removable dishwasher-proof containers
- Can be combined with a film/foil dispenser or knife holder

Ordering information

Space requirement

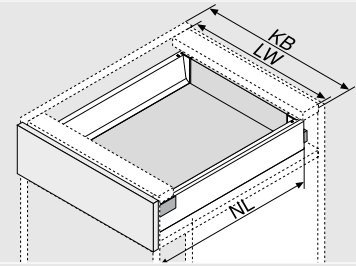

KB	Cabinet width
LW	Internal cabinet width
NL	Nominal length

Set BI1

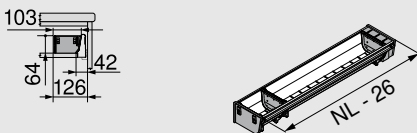

NL	Part no.
450 mm	ZSI.450BI1N
500 mm	ZSI.500BI1N
550 mm	ZSI.550BI1N

Set BI2

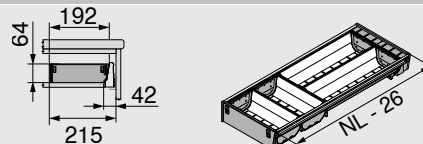

NL	Part no.
450 mm	ZSI.450BI2N
500 mm	ZSI.500BI2N
550 mm	ZSI.550BI2N

Set BI3

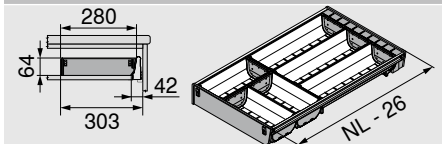

NL	Part no.
450 mm	ZSI.450BI3N
500 mm	ZSI.500BI3
550 mm	ZSI.550BI3

Set KI2

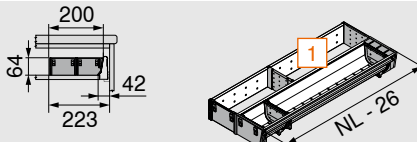

NL	Part no.
450 mm	ZSI.450KI2N
500 mm	ZSI.500KI2N
550 mm	ZSI.550KI2N

Set KI3

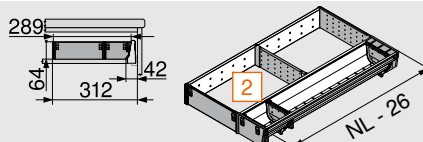

NL	Part no.
450 mm	ZSI.450KI3N
500 mm	ZSI.500KI3N
550 mm	ZSI.550KI3N

Set KI4

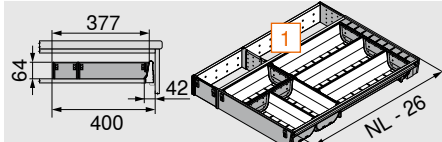

NL	Part no.
450 mm	ZSI.450KI4N
500 mm	ZSI.500KI4
550 mm	ZSI.550KI4

Set MI3

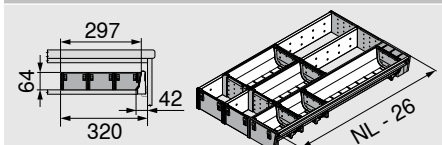

NL	Part no.
450 mm	ZSI.450MI3
500 mm	ZSI.500MI3
550 mm	ZSI.550MI3



Set FI1

NL	Part no.
450 mm	ZSI.450FI1
500 mm	ZSI.500FI1
550 mm	ZSI.550FI1

Set FI2

NL	Part no.
450 mm	ZSI.450FI2N
500 mm	ZSI.500FI2N
550 mm	ZSI.550FI2N

Set FI3

NL	Part no.
450 mm	ZSI.450FI3
500 mm	ZSI.500FI3
550 mm	ZSI.550FI3

Adjustable cross dividers

Width	Part no.
88 mm	ZSI.010Q
176 mm	ZSI.020Q

Containers

Dimensions	Part no.
88 x 88 mm	ZSI.010SI
88 x 176 mm	ZSI.020SI
88 x 264 mm	ZSI.030SI
88 x 352 mm	ZSI.040SI



ORGA-LINE for pull-outs



Cross divider, height C



Cross divider, height D

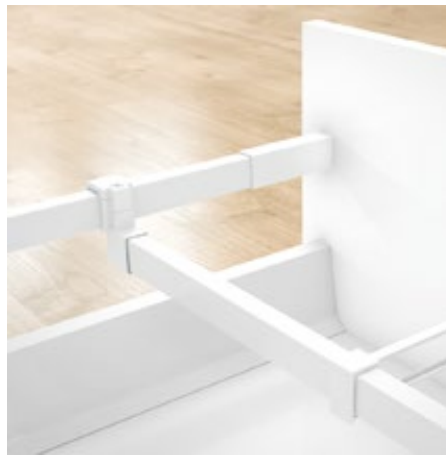

Cross gallery

TANDEMBOX antaro

Ordering information

1a Cross divider for cutting to size	
KB	Part no.
275 mm	Z40L152A
300 mm	Z40L177A
550 mm	Z40L427A
900 mm	Z40L777A
1200 mm	Z40L1077A
Silk white, RAL 9006	
Alu for cutting to size	
Cutting dimensions: X = LW - 91 mm	
Y = LW - 295 (KB 275) Y = LW - 320 mm (KB 300)	
Z = 152 mm (KB 275) Z = 177 mm (KB 300)	

1b Cross divider connector	
For gallery	Part no.
For height C	Z40C0002Z
For height D	Z40D0002Z
Silk white, white grey	

1c Cross divider connector	
	Part no.
For dividing wall	Z40L0002
Silk white, white grey	

1d Lateral divider	
	Part no.
Silk white, RAL 9006	Z43L100S

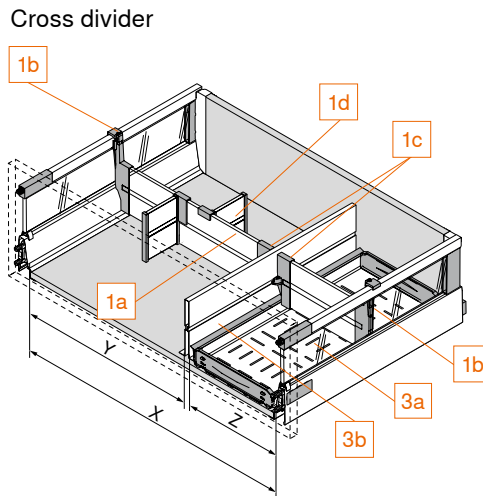

2a Cross gallery for cutting to size	
KB	Part no.
275 mm	ZRG.179Q
300 mm	ZRG.204Q
550 mm	ZRG.454Q
900 mm	ZRG.804Q
1200 mm	ZRG.1104Q
Silk white, RAL 9006	
Alu for cutting to size	
Cutting dimensions: LW - 63 mm	

2b Cross gallery connector	
	Part no.
Silk white, white grey	ZRU.01E0

2c Lateral divider for cross gallery	
	Part no.
Silk white, white grey	ZRU.11F0

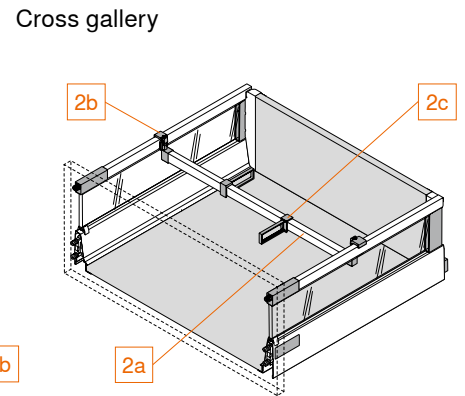

i The cross gallery cannot be used in combination with a dividing wall.

3a Bottle rack		
NL	Part no.	Part no.
450 mm		Z48.30B014
500 mm	Z48.27B016	Z48.30B016
550 mm	Z48.27B017	Z48.30B017
	KB 275 mm	KB 300 mm

3b Dividing wall	
Not available for the inner pull-out	
NL	Part no.
450 mm	Z46L420S
500 mm	Z46L470S
550 mm	Z46L520S
	Silk white, RAL 9006

KB	Cabinet width
LW	Internal cabinet width
NL	Nominal length

Recommendation for pull-outs



Recommendation for provisions and open packs of food											
NL	KB (mm)										
	275	300	400	450	500	550	600	800	900	1000	1200
450 mm	1 x QT		1 x QT, 2 x LT				1 x QT, 3 x LT				
500 mm	2 x QT		2 x QT 3 x LT				2 x QT 6 x LT				
550 mm											

Recommendation for pots, lids and cooking utensils					
NL	KB (mm)				
	600	800	900	1000	1200
450 mm	1 x QT, 2 x LT		1 x QT, 3 x LT		
500 mm	2 x QT		2 x QT, 6 x LT		
550 mm	3 x LT				

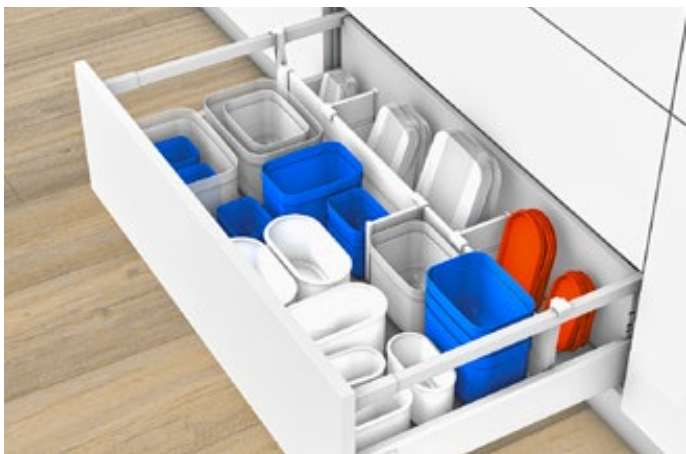

Recommendation for plastic containers											
NL	KB (mm)										
	275	300	400	450	500	550	600	800	900	1000	1200
450 mm	1 x QT		1 x QT, 2 x LT				1 x QT, 3 x LT				
500 mm	1 x QT		1 x QT, 2 x LT				1 x QT, 3 x LT				
550 mm											

Recommendation for waste separation and cleaning agents					
NL	KB (mm)				
	From 900				
450 mm	3 x QT, 1 x FW, 2 x ZW				
500 mm	4 x QT, 1 x FW, 2 x ZW				
550 mm					

Recommendation for pull-outs



Recommendation for spices			
NL	KB (mm)		
	300	400	450
450 mm	1 x QT, 2 x GH		1 x QT 2 x LT, 2 x GH
500 mm			
550 mm			

Recommendation for bottles and cutting boards										
NL	KB (mm)									
	400	450	500	550	600	800	900	1000	1200	
450 mm	3 x QT, 1 x FW, 1 x ZW				3 x QT, 1 x FW, 2 x ZW					
500 mm	4 x QT, 1 x FW, 1 x ZW				4 x QT, 1 x FW, 2 x ZW					
550 mm										



Recommendation for bottles		
NL	KB (mm)	
	275	300
450 mm	3 x QT, 1 x FW	
500 mm	4 x QT, 1 x FW	
550 mm		

Recommendation for baking trays and tins				
NL	KB (mm)			
	300	400	450	From 500
450 mm	1 x ZW			
500 mm				
550 mm				

FW	Bottle rack	KB	Cabinet width	NL	Nominal length	TH	Plate holder
GH	Spice holder	LT	Lateral divider	QT	Cross divider	ZW	Dividing wall

ORGA-LINE kitchen accessories

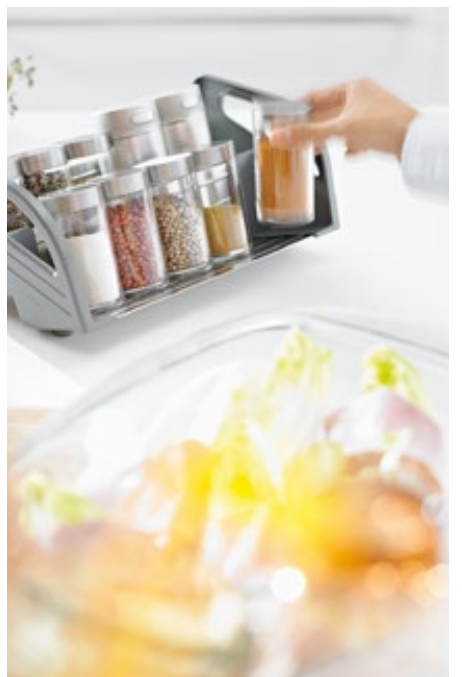

Description

- Dispenser for plastic wrap and aluminium foil for easy tangle-free dispensing
- Knife holder for safe storage of knives in the drawer
- Plate holder for easy transport and secure storage in the pull-out
- Spice holder for storage and easy access to spice containers of all sizes
- Also available as a practical complete set

Description

Film dispenser

For cling film	Part no.
Incl. film	ZSZ.01F0
Without film	ZSZ.01F1

1 1 x ZSZ.01F0
2 1 x ZSZ.01F0 + 1 x ZSZ.02F0

Foil dispenser

For aluminium foil	Part no.
Incl. foil	ZSZ.02F0
Without foil	ZSZ.02F1

1 1 x ZSZ.01F0
2 1 x ZSZ.01F0 + 1 x ZSZ.02F0

Knife holder

For 9 knives	Part no.
	ZSZ.02M0

2 1 x ZSZ.02M0

Spice holder

KB	Part no.
300 mm (width 212 mm)	ZFZ.30G0I
400 mm (width 312 mm)	ZFZ.40G0I
450 mm (width 362 mm)	ZFZ.45G0I

KB Cabinet width

Plate holder

	Part no.
Ø plates 186 – 322 mm	ZC7T0350

Overall height 170 mm
Height of storage items – up to 12 plates

Kitchen accessory set

	Part no.
Set	ZOU.30U1I

Consisting of:
 1 x knife holder
 1 x film dispenser (incl. film)
 1 x foil dispenser (incl. foil)
 2 x spice holders (for KB 300 mm)
 2 x plate holders

Placement of kitchen accessories

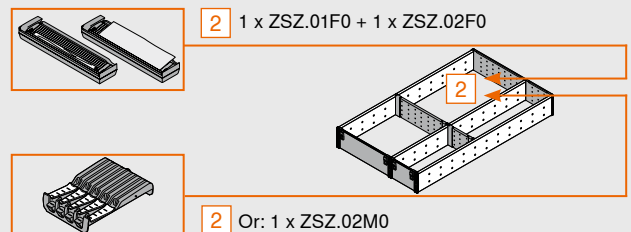
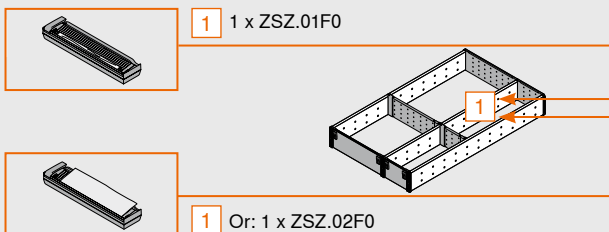

Bluran
Import & Distribution Ltd.
2nd, Ha'Mada St.
P.O.B 5235
Ind. Zone Me'uyan Soreq
Rishon Le Zion 7515102, Israel
Tel.: +972 732 310360
Fax: +972 732 310361
E-mail: bluran@bluran.co.il
www.bluran.co.il

Julius Blum GmbH
6973 Höchst, Austria
Tel.: +43 5578 705-0
Fax: +43 5578 705-44
E-mail: info@blum.com
www.blum.com

Our sites in Austria, Poland and China are certified to the international standards mentioned below.
Our site in the USA is certified to ISO 9001.
Our site in Brazil is certified to ISO 9001, ISO 14001 and ISO 45001.



ISO 9001
Certified Quality
System



ISO 14001
Certified Environmental
System



ISO 50001
Certified Energy
System

 **blum**[®]



Look for our
FSC™-certified
products

All content is copyrighted by Blum.
Subject to technical modifications and changes to the range without notice.
IDNR: 185.6317 · EP-546/3 · EN-IL/03.24