



# CLIP top BLUMOTION 105°

Novi standard

[www.blum.com](http://www.blum.com)

 **blum**<sup>®</sup>



# Svuda ubedljivo

CLIP top BLUMOTION 105° postavlja novi standard: sa integrisanim prigušenjem i visokim komforom kretanja. Jednostavno za obradu i jednostavno za montažu. Sa udobnim, trodimenzionalnim podešavanjem za ujednačen izgled fuge. Vitak kompaktni dizajn koji je pogodan za mnoštvo primena. I uravnotežen odnos cene i učinka.

CLIP top BLUMOTION 105° – savršeno rešenje. Za sve stambene oblasti.

## Prednosti proizvoda na prvi pogled



Vitki dizajn zahvaljujući BLUMOTION prigušenju integrisanom u loncu šarke



Montaža bez alata sa proverenim CLIP mehanizmom

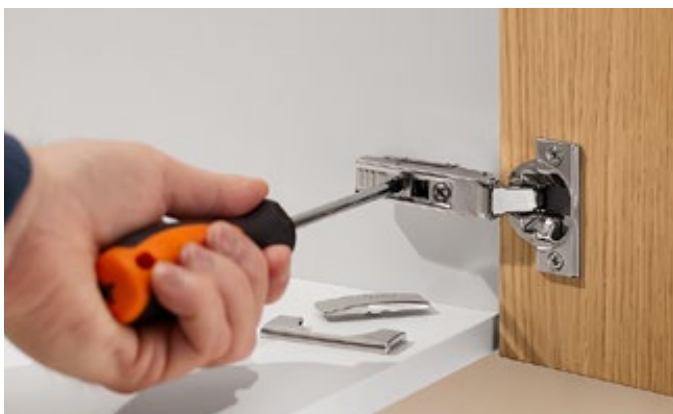

3-dimenzionalno podešavanje fronta, bestepeno podešavanje po dubini preko navojnog puža



Tanak dizajn sa mnogo mogućih primena



Namenjeno i sertifikovano za upotrebu u kuhinji (DIN 15570 nivo 3)

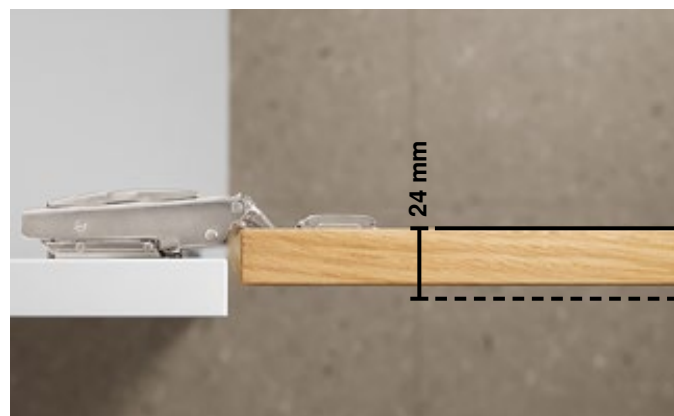







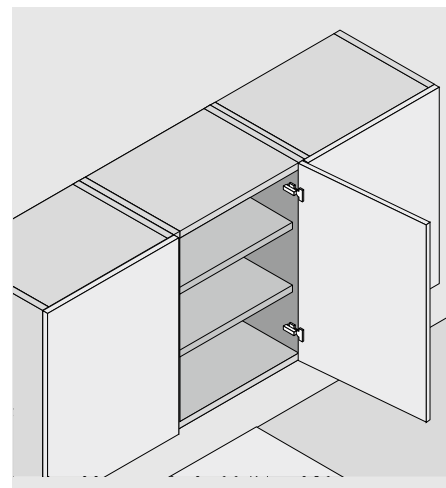







Pogodno za debljinu fronta do približno 24 mm









- CLIP top BLUMOTION 105° sa integrisanim BLUMOTION prigušenjem
- CLIP top 105° sa ili bez automata za zatvaranje (opruga)
- Ugao otvaranja 105°
- 3-dimenzionalno podešavanje fronta
- Komforno podešavanje po dubini preko navojnog puža
- Montaža i demontaža fronta na korpus bez alata



## Informacije za naručivanje

 <b>Lonac</b> <input type="checkbox"/> Zavrtanje			 		 		 	
Šarka	Opruga	Boja	Ugaono naleganje	Središnje naleganje	Unutrašnje naleganje			
CLIP top BLUMOTION	●	NI	75B2550	75B2650	75B2750			
CLIP top	●	NI	75T2550	75T2650	75T2750			
	○	NI	74T2550.TL	74T2650.TL	74T2750.TL			
 <b>Lonac</b> <input type="checkbox"/> Utiskivanje			 		 		 	
Šarka	Opruga	Boja	Ugaono naleganje	Središnje naleganje	Unutrašnje naleganje			
CLIP top BLUMOTION	●	NI	75B2580	75B2680	75B2780			
CLIP top	●	NI	75T2580					

### Pokrivna kapica držača šarke

			 		 		 	
Štampa / utiskivanje	Natpis	Boja	Ugaono naleganje	Središnje naleganje	Unutrašnje naleganje			
Bez štampe	–	NI	70.1503	70.1663	70.1663			
Utisnuto	Blum	NI	70.1503.BP	70.1663.BP	70.1663.BP			

● Šarka sa oprugom

○ Šarka bez opruge

NI Niklovano

## Informacije za naručivanje

Pokrivna kapica lonca šarke		
	<b>Boja</b>	
	NI	70T3504
NI Niklovano		

Graničnik ugla otvaranja		
	<b>Ugao otvaranja</b>	<b>Boja</b>
	85°	R7037
	R7037	RAL 7037 svetlo siva
		94M2553

Razmak lonca šarke		
	<b>Lonac</b>	
	Zavrtnje	70T3507.21
	1,5 mm	

Zavrtnj za ivericu		
	<b>Ø (mm)</b>	<b>Dužina (mm)</b>
	3,5	15
	3,5	17
		609.1500
		609.1700

TIP-ON za vrata			
	<b>Model</b>	<b>TIP-ON opruga</b>	<b>Opruga</b>
	Kratka verzija	■	○
	Dugačka verzija	■	○
	Dugačka verzija	■	●
	Dugačka verzija	■ ■	●
	Dugačka verzija	■ ■	●
<b>TIP-ON opruga</b>			<b>Opruga</b>
■ Standardna opruga			● Šarka sa oprugom
■ ■ Jaka opruga			○ Šarka bez opruge
			956.1004
			956A1004
			956A1006
			956A1006F



Dodatne informacije pogledajte na:  
[www.blum.com/ctb2](http://www.blum.com/ctb2)

## Planiranje

### Dimenzije šarke i izračunavanje fuga kod fabričkog podešavanja (udaljenost montažnih ploča = 0 mm)

Prostor koji zahvata front kod punog ugla otvaranja

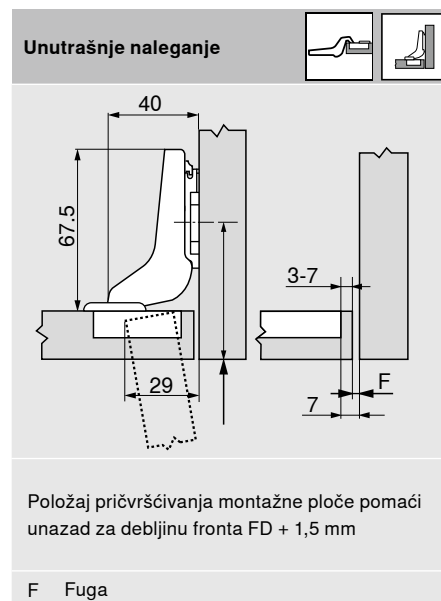
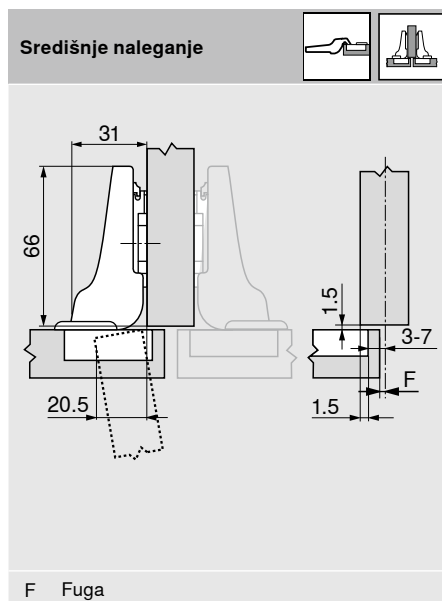
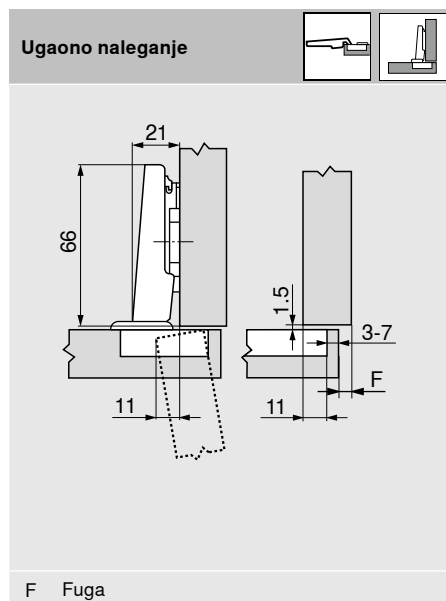

### Rastojanje lonca TB

MD	Preklapanje fronta FA (mm)														
	5	6	7	8	9	10	11	12	13	14	15	16	17	18	
0											3	4	5	6	7
3								3	4	5	6	7			
6				3	4	5	6	7							
9	3	4	5	6	7										

MD Udaljenost montažne ploče (mm)

MD	Preklapanje fronta FA (mm)															
	-4.5	-3.5	-2.5	-1.5	-0.5	0.5	1.5	2.5	3.5	4.5	5.5	6.5	7.5	8.5		
0												3	4	5	6	7
3								3	4	5	6	7				
6				3	4	5	6	7								
9	3	4	5	6	7											

MD Udaljenost montažne ploče (mm)

MD	Preklapanje fronta FA (mm)											
	-7	-6	-5	-4	-3	-2	-1	0				
0								3	4	5	6	7
3								3	4	5	6	7
6												
9												

MD Udaljenost montažne ploče (mm)

### Minimalna fuga fuge F za frontove sa poluprečnikom fronta (R = 1 mm) kod fabričkog podešavanja

Rastojanje lonca TB (mm)	Debljina fronta FD (mm)							
	16	18	19	20	21	22	24	
3	0.5	0.8	1.0	1.2	1.5	1.8	2.7	
4	0.5	0.8	1.0	1.2	1.4	1.7	2.5	
5	0.5	0.8	0.9	1.2	1.4	1.7	2.4	
6	0.5	0.8	0.9	1.2	1.3	1.6	2.3	
7	0.5	0.8	0.9	1.1	1.3	1.6	2.2	
	<b> dodatno kod +2 mm podešavanje stranica</b>							
	+0.3	+0.3	+0.3	+0.4	+0.4	+0.4	+0.4	+0.4

### Podešavanje

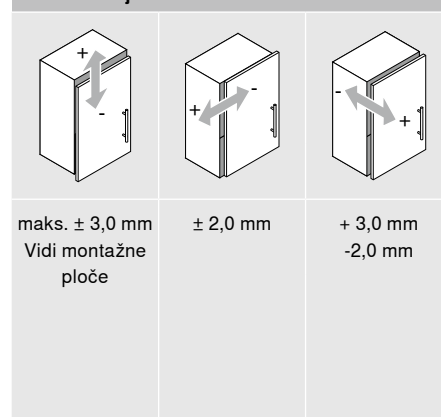

### Montaža zavrtnjima

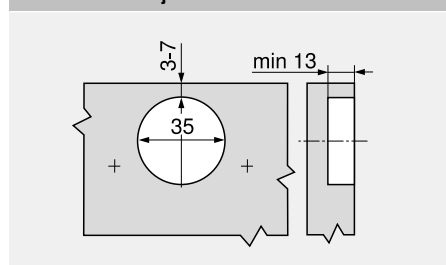

### Montaža utiskivanjem

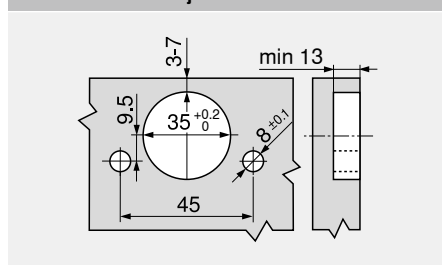

### Dimenzije lonca

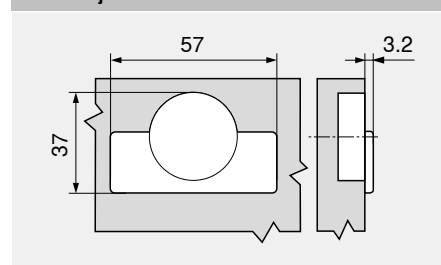

Julius Blum GmbH  
A-6973 Höchst, Austria  
Tel.: +43 5578 705-0  
Faks: +43 5578 705-44  
E-mail: [info@blum.com](mailto:info@blum.com)  
[www.blum.com](http://www.blum.com)

Naše lokacije u Austriji, Poljskoj i Kini su sertifikovane kao što je navedeno u danjem tekstu.  
Naša lokacija u SAD je sertifikovana u skladu sa ISO 9001.  
Naša lokacija u Brazilu je sertifikovana u skladu sa ISO 9001, ISO 14001 i ISO 45001.



Celokupan Blum sadržaj je podložan zakonu o kopiranju (Copyright).  
Zadržano pravo na tehničke izmene i izmene programa.  
IDNR: 354.896.1 · FO-209/1 SR-AL/02.25

Look for our  
FSC™-certified  
products