



CLIP top BLUMOTION pod kutom od 105°

Provjereno, ali s novim dizajnom

www.blum.com

 **blum**[®]

Očaravajuće rješenje

Mnogo je toga ostalo isto: pouzdani CLIP mehanizam. Jednostavna obrada i montaža. Kompaktna izvedba. Elegantan, puristički dizajn. Visoka kvaliteta proizvodnje. Međutim, ponešto se promijenilo: spojnica je svedena na ono najvažnije. Pojednostavljeni, ali unatoč tomu učinkoviti sustav prigušivanja. I odgovarajući omjer cijene i kvalitete.

Zahvaljujući svemu tomu, spojnica CLIP top BLUMOTION pod kutom od 105° očaravajuće je rješenje za standardne primjene u svim stambenim prostorima.





Prednosti proizvoda



Tanak dizajn zahvaljujući prigušivanju BLUMOTION integriranom u čašicu spojnice



Montaža bez alata s pouzdanim CLIP mehanizmom

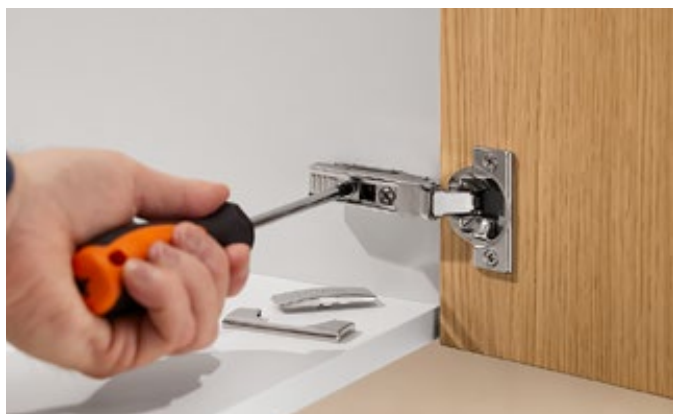

3-dimenzionalno namještanje fronte, kontinuirano podešavanje dubine preko opružnog vijka

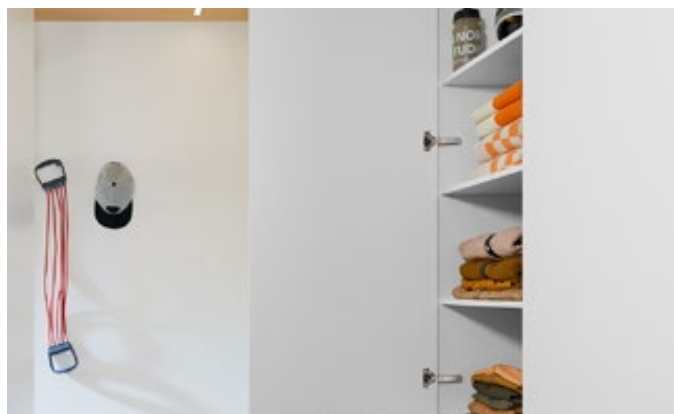

Tanki dizajn s brojnim mogućnostima primjene

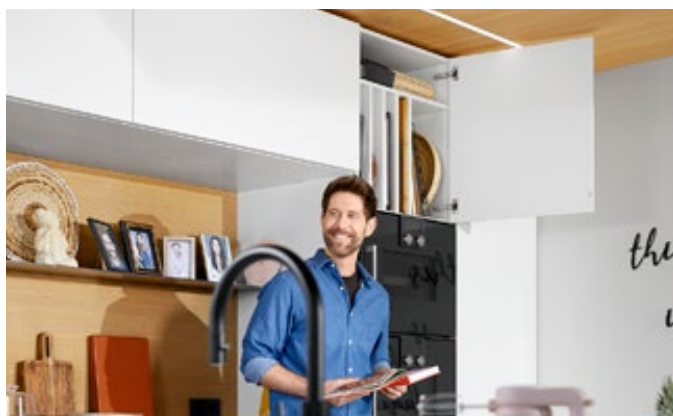

Dizajnirano i certificirano za upotrebu u kuhinji (norma DIN 15570, stupanj 3)

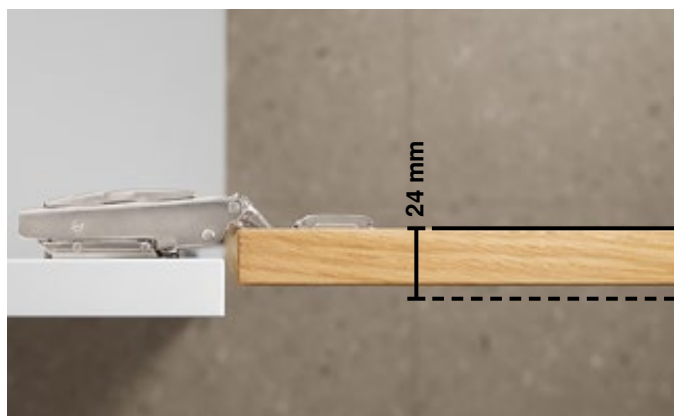







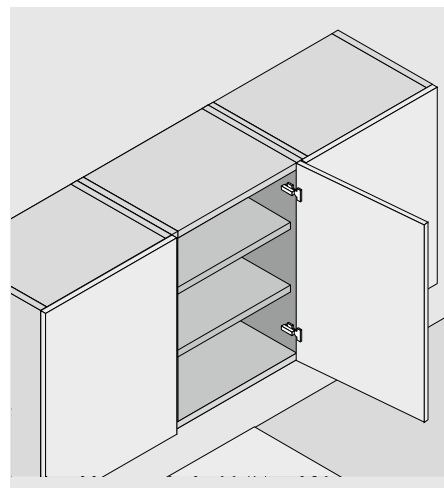







Prikladno za debljine fronte do oko 24 mm





- CLIP top BLUMOTION pod kutom od 105° s integriranim prigušivanjem BLUMOTION
- CLIP top pod kutom od 105° s automatskim zatvaranjem (opruga) ili bez njega
- Kut otvaranja 105°
- 3-dimenzionalno namještanje fronte
- Praktično podešavanje dubine s pomoću opružnog vijka
- Montaža i demontaža fronte na korpus bez alata



Podaci za narudžbu

 Čašica spojnice <input type="checkbox"/> Pričvršćivanje vijkom			 		 		 	
Spojnica	Opruga	Boja	Kutno pričvršć. vrat. krila	Sred. pričvršć. vrat. krila	Pričvršć. vrat. krila unutar str. korpusa			
CLIP top BLUMOTION	●	NI	75B2550	75B2650	75B2750			
CLIP top	●	NI	75T2550	75T2650	75T2750			
	○	NI	74T2550.TL	74T2650.TL	74T2750.TL			
 Čašica spojnice <input type="checkbox"/> Utiskivanje			 		 		 	
Spojnica	Opruga	Boja	Kutno pričvršć. vrat. krila	Sred. pričvršć. vrat. krila	Pričvršć. vrat. krila unutar str. korpusa			
CLIP top BLUMOTION	●	NI	75B2580	75B2680	75B2780			
CLIP top	●	NI	75T2580					

Pokrivna kapica kraka spojnice					
					
Tiskanje/utiskivanje	Natpis	Boja	Kutno pričvršć. vrat. krila	Sred. pričvršć. vrat. krila	Pričvršć. vrat. krila unutar str. korpusa
Neotisnut	-	NI	70.1503	70.1663	70.1663
Utisnut	Blum	NI	70.1503.BP	70.1663.BP	70.1663.BP

● Spojnica s oprugom
 ○ Spojnica bez opruge
 NI Poniklano

Podaci za narudžbu

Pokrivna kapica čašice spojnice		
	Boja	
	NI	70T3504
NI Poniklano		

Graničnik kuta otvaranja		
	Kut otvaranja	Boja
	85°	R7037
	R7037	RAL 7037 prašnjavo siva
		94M2553

Razmak čašice spojnice		
	Čašica spojnice	
	Pričvršćivanje vijkom	70T3507.21
	1,5 mm	

Vijak za ivericu		
	Ø (mm)	Duljina (mm)
	3,5	15
	3,5	17
		609.1500
		609.1700

TIP-ON za vrata			
	Izvedba	Opruga TIP-ON	Opruga
	Kratka verzija	■	○
	Duga verzija	■	○
	Duga verzija	■	●
	Duga verzija	■ ■	●
	956.1004		956A1004
956A1006		956A1006F	
Opruga TIP-ON		Opruga	
■ Standardne opruge		● Spojnica s oprugom	
■ ■ Čvrste opruge		○ Spojnica bez opruge	



Dodatne informacije možete pronaći na:
www.blum.com/ctb1

Planiranje

Tvorničke postavke dimenzija spojnica i izračun širine razmaka (udaljenost montažne podloške = 0 mm)

Uskakanje fronte pri punom kutu otvaranja

Kutno pričvršćivanje vratnog krila

F Razmak

Središnje pričvršćivanje vratnog krila

F Razmak

Pričvršćivanje vratnog krila unutar stranica korpusa

Položaj pričvršćivanja montažne podloške vijcima potrebno je pomaknuti unazad za debljinu fronte $FD + 1,5$ mm

F Razmak

Udaljenost čašice TB

MD	Otvaranje fronte FA (mm)															
	5	6	7	8	9	10	11	12	13	14	15	16	17	18		
0												3	4	5	6	7
3											3	4	5	6	7	
6				3	4	5	6	7								
9	3	4	5	6	7											

MD Udaljenost montažne podloške (mm)

MD	Otvaranje fronte FA (mm)																
	-4.5	-3.5	-2.5	-1.5	-0.5	0.5	1.5	2.5	3.5	4.5	5.5	6.5	7.5	8.5			
0													3	4	5	6	7
3													3	4	5	6	7
6					3	4	5	6	7								
9	3	4	5	6	7												

MD Udaljenost montažne podloške (mm)

MD	Otvaranje fronte FA (mm)														
				-7	-6	-5	-4	-3	-2	-1	0				
0											3	4	5	6	7
3											3	4	5	6	7
6					3	4	5	6	7						
9	3	4	5	6	7										

MD Udaljenost montažne podloške (mm)

Najmanji bočni razmak razmaka F za fronte s polumjerom fronte (R = 1 mm) kod tvorničke postavke

	Udaljenost čašice TB (mm)	Debljina fronte FD (mm)							
		16	18	19	20	21	22	24	
	3	0.5	0.8	1.0	1.2	1.5	1.8	2.7	
	4	0.5	0.8	1.0	1.2	1.4	1.7	2.5	
	5	0.5	0.8	0.9	1.2	1.4	1.7	2.4	
	6	0.5	0.8	0.9	1.2	1.3	1.6	2.3	
	7	0.5	0.8	0.9	1.1	1.3	1.6	2.2	
		 dodatno pri +2 mm bočnog podešavanja							
		+0.3	+0.3	+0.3	+0.4	+0.4	+0.4	+0.4	

Namještanje

maks. $\pm 3,0$ mm Pogledajte montažne podloške	$\pm 2,0$ mm	+ 3,0 mm -2,0 mm
--	--------------	---------------------

Montaža vijcima

Montaža prešanjem

Dimenzije čašice

Julius Blum GmbH
6973 Höchst, Austria
Tel.: +43 5578 705-0
Fax: +43 5578 705-44
E-mail: info@blum.com
www.blum.com

Naše lokacije u Austriji, Poljskoj i Kini certificirane su u skladu s normama navedenima u nastavku.
Naša lokacija u SAD-u certificirana je u skladu s normom ISO 9001.
Naša lokacija u Brazilu certificirana je u skladu s normama ISO 9001, ISO 14001 i ISO 45001.



Cjelokupan sadržaj Blum je podložan zakonu o umnožavanju (Copyright).
Pridržavamo pravo na tehničke i programске izmjene.
IDNR: 520.380.5 · FO-208/1 HR-AL/02.25

Look for our
FSC™-certified
products