

CLIP top BLUMOTION 105°

Nuevo concepto de la calidad de siempre

www.blum.com

 **blum**[®]

Una solución convincente

Muchas cosas siguen igual: el mecanismo CLIP probado. Ajuste y montaje sencillos. Diseño compacto. Diseño elegante y minimalista. La gran calidad de fabricación. Pero algunas cosas cambiaron: con una reducción a lo esencial. Un sistema de amortiguación simplificado pero igualmente eficaz. Y una relación precio-calidad equilibrada.

Todo eso convierte a CLIP top BLUMOTION 105° en una solución convincente para aplicaciones estándar en todas las estancias del hogar.





Resumen de las ventajas del producto



Diseño elegante gracias a la amortiguación BLUMOTION integrada en la cazoleta de la bisagra



Montaje sin herramientas con el mecanismo CLIP probado



Ajuste tridimensional del frente, ajuste de profundidad continuo con espiral

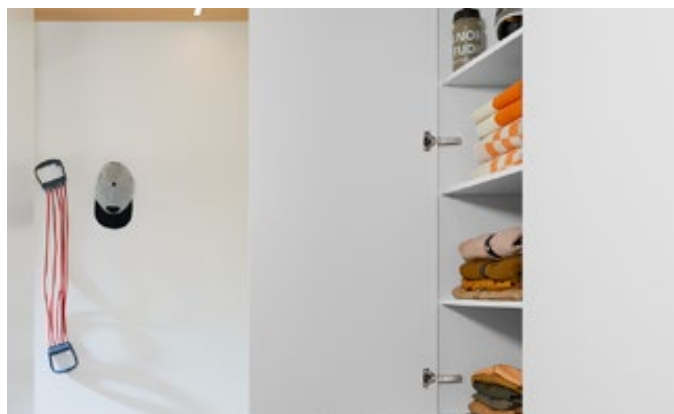

Diseño elegante con múltiples posibilidades de uso

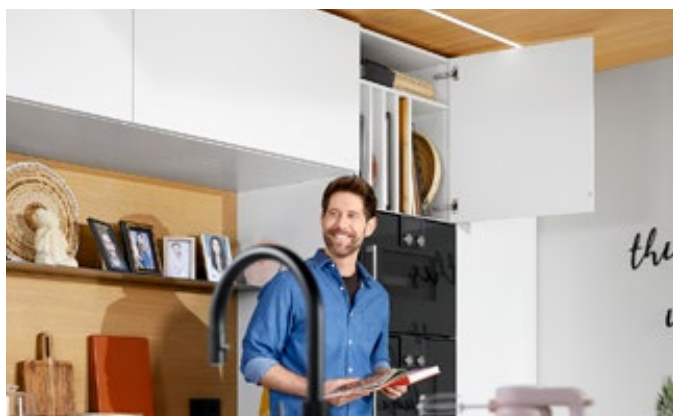

Diseñado y certificado para el uso en la cocina (DIN 15570, nivel 3)

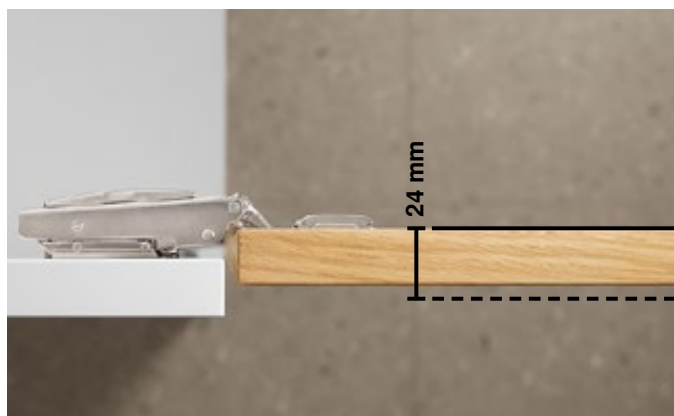



Adecuado para espesores de frentes hasta aprox. 24 mm



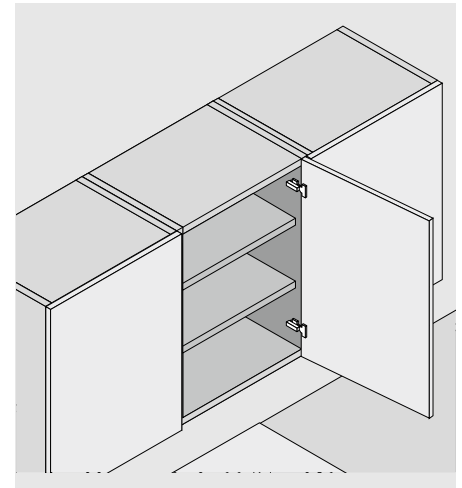



- CLIP top BLUMOTION 105° con amortiguación BLUMOTION integrada
- CLIP top 105° con o sin automatismo de cierre (muelle)
- Ángulo de apertura de 105°
- Ajuste tridimensional del frente
- Ajuste cómodo de la profundidad con espiral
- Montaje y desmontaje sin herramientas del frente en el cuerpo de mueble



Información de pedido

 Cazoleta <input type="checkbox"/> Para atornillar			 		 		 	
Bisagra	Muelle	Color	Tope de esquina	Tope central	Tope interior			
CLIP top BLUMOTION	●	NI	75B2550	75B2650	75B2750			
CLIP top	●	NI	75T2550	75T2650	75T2750			
	○	NI	74T2550.TL	74T2650.TL	74T2750.TL			
 Cazoleta <input type="checkbox"/> Para encajar a presión			 		 		 	
Bisagra	Muelle	Color	Tope de esquina	Tope central	Tope interior			
CLIP top BLUMOTION	●	NI	75B2580	75B2680	75B2780			
CLIP top	●	NI	75T2580					

Tapa para bisagras						
			 		 	
Impresión/estampado	Rótulo	Color	Tope de esquina	Tope central	Tope interior	
Sin impresión	-	NI	70.1503	70.1663	70.1663	
Estampado	Blum	NI	70.1503.BP	70.1663.BP	70.1663.BP	

● Bisagra con muelle
 ○ Bisagra sin muelle
 NI Niquelado

Información de pedido

Tapa de cazoleta de bisagra		
	Color	
	NI	70T3504
NI Niquelado		

Limitador de apertura		
	Ángulo de apertura	Color
	85°	R7037
	R7037	RAL 7037 gris polvo
		94M2553

Distanciador de cazoleta de bisagra		
	Cazoleta	
	Para atornillar	70T3507.21
	1,5 mm	

Tornillo aglo		
	Ø (mm)	Longitud (mm)
	3,5	15
	3,5	17
		609.1500
		609.1700

TIP-ON para puertas			
	Versión	Muelle TIP-ON	Muelle
	Versión corta	■	○
	Versión larga	■	○
	Versión larga	■	●
	Versión larga	■ ■	●
Muelle TIP-ON		Muelle	
■ Muelle estándar		● Bisagra con muelle	
■ ■ Muelle reforzado		○ Bisagra sin muelle	
		956.1004	
		956A1004	
		956A1006	
		956A1006F	



Más información en:
www.blum.com/ctb1

Julius Blum GmbH
6973 Höchst, Austria
Tel.: +43 5578 705-0
Fax: +43 5578 705-44
E-Mail: info@blum.com
www.blum.com

Nuestras sedes en Austria, Polonia y China están certificadas de acuerdo con lo indicado abajo.
Nuestra sede en EE. UU. está certificada según la norma ISO 9001.
Nuestra sede en Brasil está certificada según las normas ISO 9001, ISO 14001 e ISO 45001.



ISO 9001
Certified Quality
System



ISO 14001
Certified Environmental
System



ISO 50001
Certified Energy
System

 **blum**®



Look for our
FSC™-certified
products

Todo el contenido está sujeto al Copyright de Blum.
Sujeto a modificaciones técnicas y modificaciones de programa sin previo aviso.
IDNR: 783.649.0 · FO-208/1 ES-AL/02.25