

# EXPANDO T

Thin fronts,  
easily assembled

8 mm





# Rediscover simplicity

Minimalist design creates room for inspiration. Broaden the range of your possibilities for implementing trends in furniture manufacturing. The first fixing system for thin fronts for lift systems, doors and pull-outs makes minimalist furniture design simple.



Detailed information  
on the awards:  
[www.blum.com/award](http://www.blum.com/award)

# Easily implemented: three applications

To make it as easy as possible for you we have developed a fixing system that you can use to implement a total of three applications: lift systems, doors and pull-outs. Furniture impresses with thin fronts and proven Blum functionality – in all living areas.







## An easily assembled system

Our fixing system for thin fronts is based on EXPANDO T. Steel teeth bite into the material of hard fronts, and nylon components ensure firm anchorage in soft panels. To fix EXPANDO T, drill a hole of 10 mm in diameter and just 6 mm in depth.

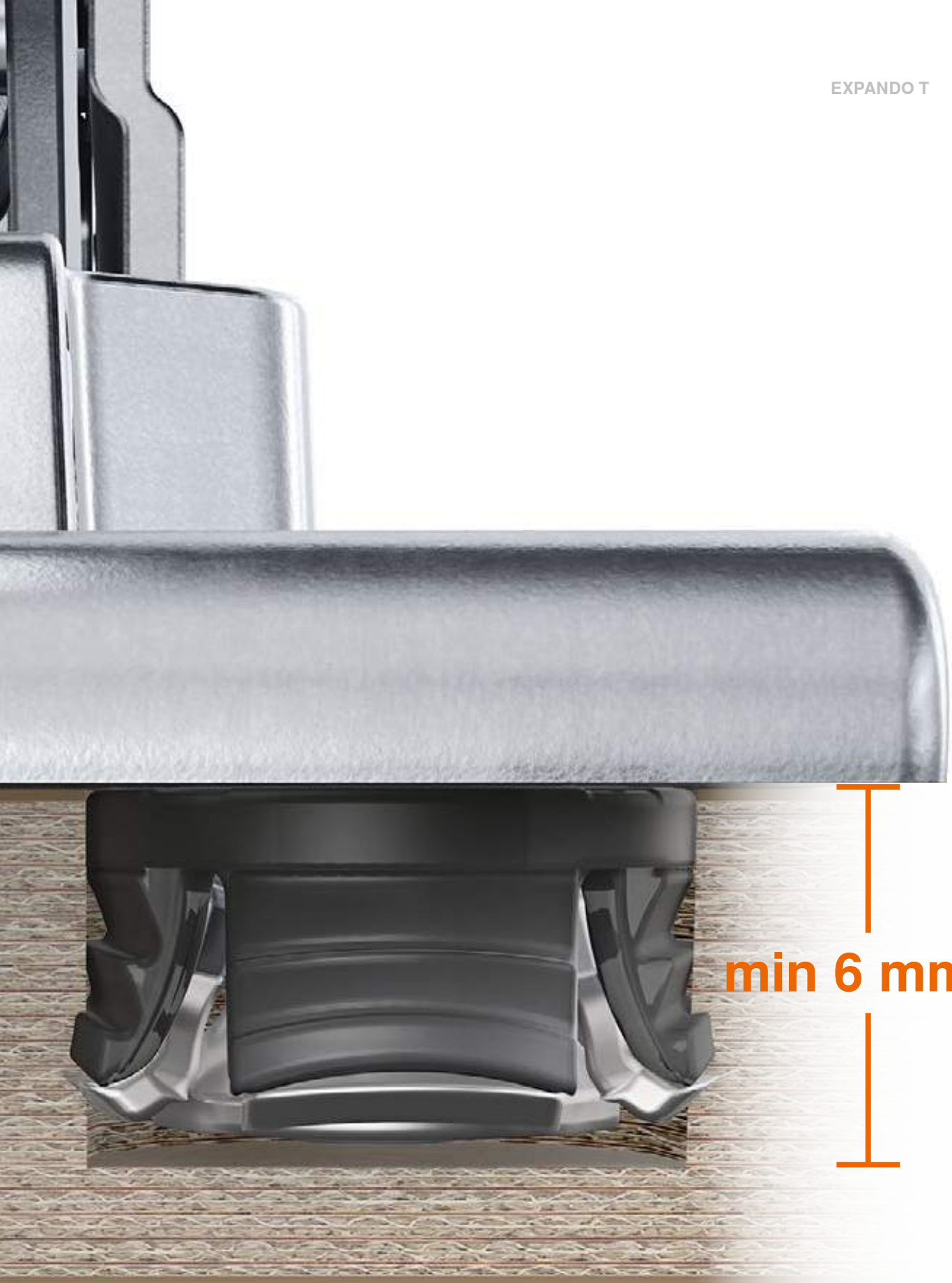

**min 6 mm**

# Assembly made easy

Wall cabinets, doors and pull-outs equipped with EXPANDO T for thin fronts all have one thing in common, they are easy to assemble and adjust. Drill, insert and tighten screws. That's it. EXPANDO T is also available as a single dowel for other applications.



With the fixing mechanism for CLIP top BLUMOTION for thin doors, we have succeeded in integrating the BLUMOTION functionality into hinges – without any need for a hinge boss. Thanks to zero protrusion, this hinge is also suitable for cabinets with inner pull-outs or pull-out shelves.





Chosen lift system types –  
AVENTOS HS, HL and  
HK top – can be implemented  
with the fixing system for  
thin fronts – with an unchanged  
fixing position.



Thin fronts best bring out the  
streamline design of LEGRABOX  
and MERIVOBX drawers.  
Fixing positions remain the  
same so fronts can be  
assembled in next to no time.



# Easily combined materials

Our fixing system EXPANDO T for thin fronts from 8 mm is suitable for many materials and even allows for exceptional design ideas. Surprise your customers with customised furniture.

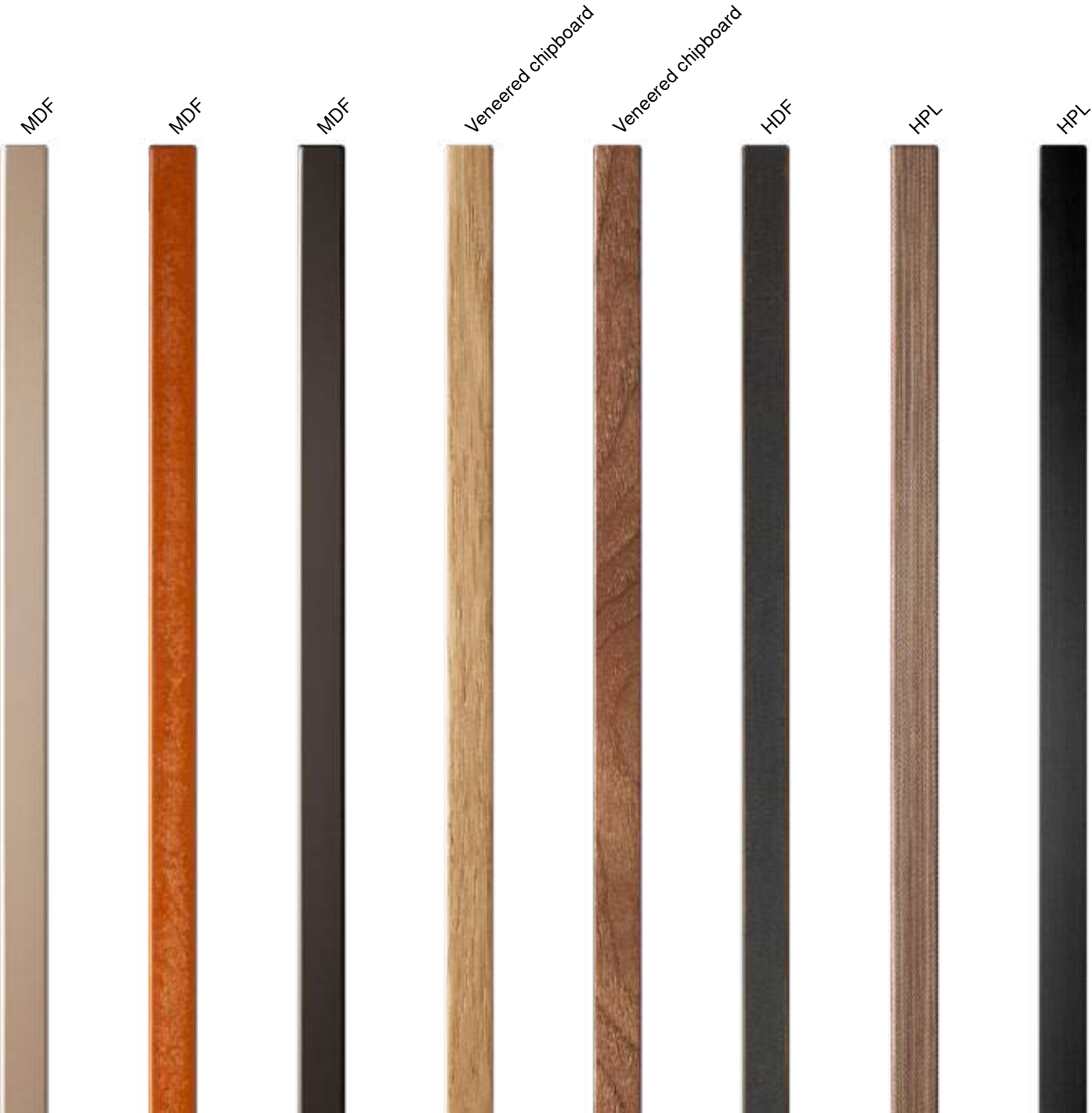

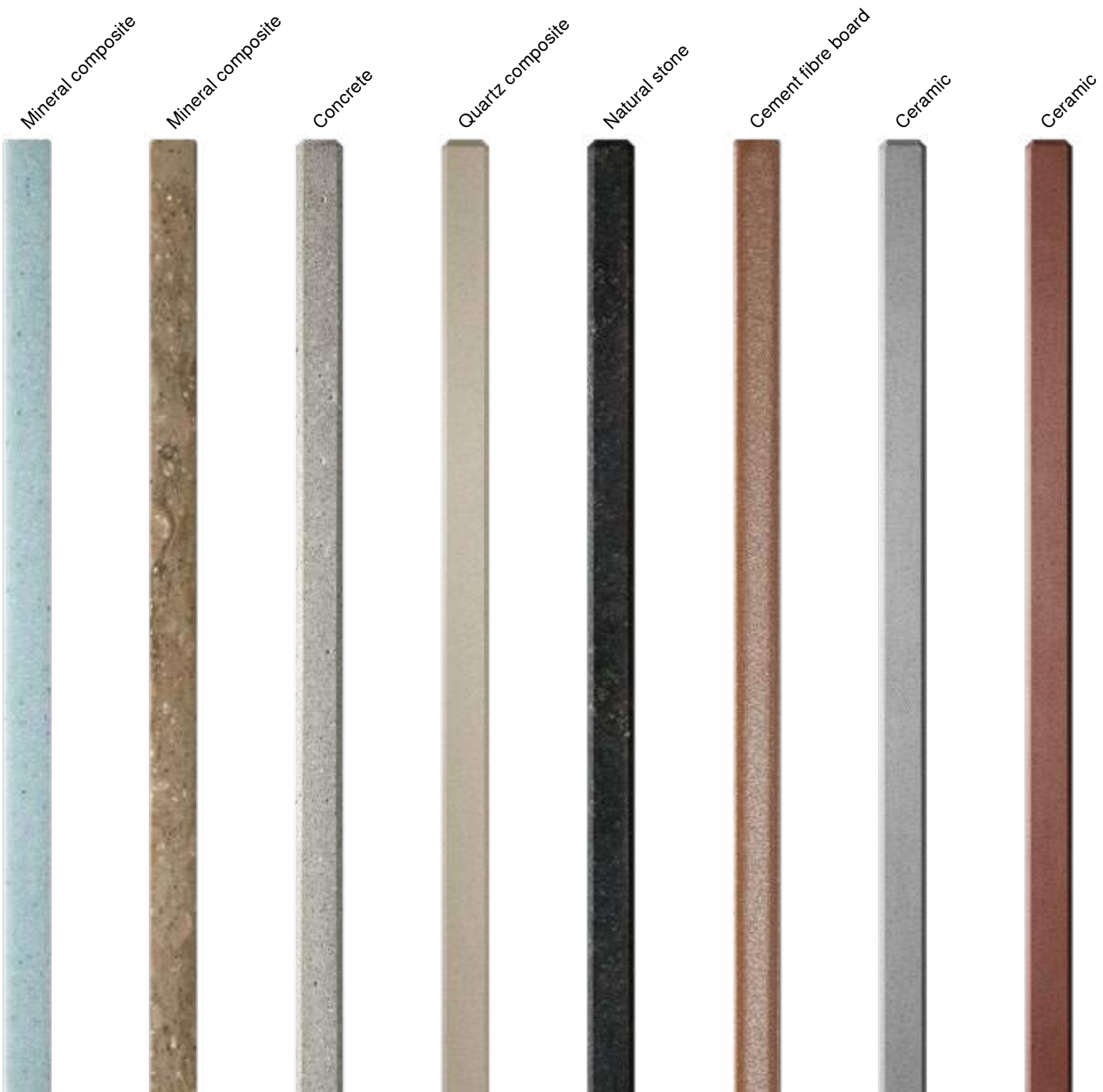







*blum*

HDF









Veneered chipboard

MDF











HPL









Ceramic











Ceramic









MDF



EXPANDO T





# Trim and concise range

A single fixing system for three applications with thin fronts makes product selection and ordering significantly easier. Implement different lift system types, LEGRABOX and MERIVOBX pull-outs in different heights as well as conventional door applications – with few components.

## Advantages at a glance

- 3 different applications – lift systems | hinge systems | box systems
- Thin fronts of 8 mm or more
- EXPANDO T – pre-assembled fixing system
- Different front materials
- Use the online Product Configurator – which calculates all dimensions for your planning in the drawings





## Ordering information

Wall cabinet fronts			
AVENTOS HS   HL   HK top			
Front fixing bracket			
	Version	Material	
	Symmetrical	Steel	ZF4.10T2
Fixing positions according to the Blum catalogue			

Hinge systems				
CLIP top BLUMOTION   CLIP top				
Hinge for thin doors				
	Hinge	Spring	Colour	
	CLIP top BLUMOTION	●	NI   ONS	71B453T
	CLIP top	●	NI	71T453T
	CLIP top	○	NI	70T453T.TL
The different overlay applications can be achieved with the appropriate fixing positions				
<ul style="list-style-type: none"> <li>● With spring</li> <li>○ Unsprung</li> </ul>				

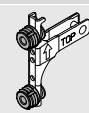
Box systems		
LEGRABOX		
Front fixing bracket		
	Height	
	N	ZF7N70T2
	M	ZF7M70T2
	K	ZF7K70T2
	C	ZF7C70T2
Height F and fixing positions according to the Blum catalogue		

Box systems		
MERIVOBX		
Front fixing bracket		
	Fixing method	
	EXPANDO T	ZF4.10T2
Fixing positions according to the Blum catalogue		

MERIVOBX		
Front fixing bracket, top		
	Fixing method	
	EXPANDO T	ZF4.50T2
Fixing positions according to the Blum catalogue		

Box systems			
LEGRABOX   MERIVOBX			
Front/base stabiliser for thin fronts			
	Colour	Material	
	R7037	Nylon	Z96.00T1
Fixing positions according to the Blum catalogue			
<b>Recommendation:</b>			
Cabinet width (KB) > 600 mm: 1 pc			
Cabinet width (KB) > 900 mm: 2 pc			
Front height (FH) > 380 mm: 1 pc			

Further products			
EXPANDO T – single			
	Colour	Material	
	TGR	Nylon/steel	70T4532T

Colour			
NI	Nickel plated	TGR	Dark grey
ONS	Onyx black	R7037	RAL 7037 dust grey

## Planning

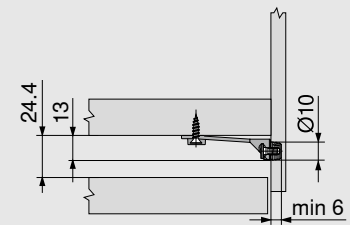
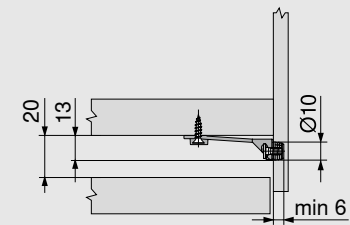
Space requirements in the cabinet	
<p><b>LEGRABOX</b></p> 	<p><b>MERIVOBX</b></p> 

## Planning

### Drilling distances – front

#### LEGRABOX

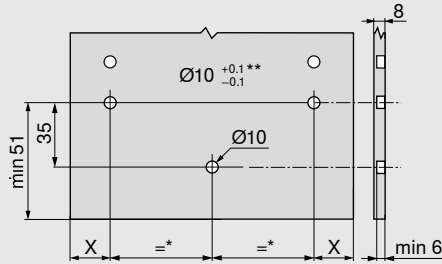

#### MERIVOBX

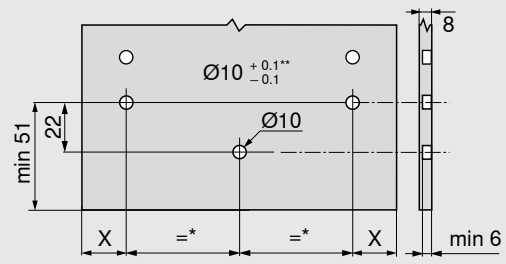

X = 14 mm + front overlay FA

\* Min. 80 mm

\*\* For stone and ceramics +0.2/-0.1 mm

### Drilling depth | Screw selection – EXPANDO T

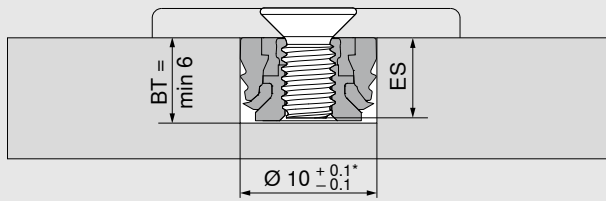

Screws with M4 thread have to be used for EXPANDO T single

The lowest possible drilling depth should be selected for the single dowel, depending on the screw length

BT Drilling depth

ES Screw penetration depth

ES min = 4 mm

ES max = BT - 0.5 mm

\* For stone and ceramics +0.2/-0.1 mm

### Assembly of EXPANDO T

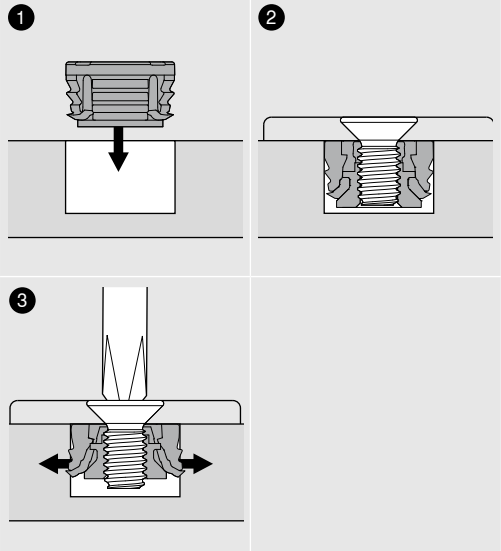

### Area of application and assembly recommendation

EXPANDO T is suitable for fixing Blum fittings to thin cabinet fronts of all types of materials.

Panels can be just 8 mm thick or more, provided they are sufficiently stable and strong.

Nm Minimum tightening torque

#### Materials tested by Blum

Chipboard	> 0.40	1.5
MDF	> 0.60	1.5
HDF		2
HPL		2
Mineral composites		2
Granite stone – Nero Assoluto		3
Artificial stone – quartz composite		3
Ceramic panels		3

#### Transverse tensile strength (N/mm<sup>2</sup>)

Nm



Information on assembly and adjustment

[www.blum.com/EXPANDO\\_T\\_3](http://www.blum.com/EXPANDO_T_3)

### Liability disclaimer

Blum accepts no liability for the use of EXPANDO T in combination with materials not listed or fittings from other manufacturers. It is recommended that assembly be carried out by an experienced furniture manufacturer.

# Support every step of the way

In addition to our practical assembly devices, we offer you numerous digital services that support you along the entire process chain - from planning and selection, to ordering and installation. We would also be delighted to advise you in person.

## Marketing

### Marketing Media Library

Use our high-resolution images, videos and brochures for your promotion campaigns and gain inspiration.

## Concept, planning, quotation

### Blum Inspirations

Inspire your customers with practical cabinet applications. We have compiled inspiring reports and background information for you at [www.blum-inspirations.com](http://www.blum-inspirations.com).

## Design

### Product and Cabinet Configurator

Design, configure and save your projects online with ease – with our free Product and Cabinet Configurator.

## Ordering

### Distributor interface

Transfer your parts list from the Product and Cabinet Configurator directly to the web shop of selected distributors.





## Manufacturing

### **MINIPRESS top with EASYSTICK**

You receive manufacturing data from our Cabinet Configurator or your CAD software, so that you can transfer and edit your planning on MINIPRESS top with EASYSTICK.

## Assembly

### **EASY ASSEMBLY app**

Use our EASY ASSEMBLY app to install and adjust our fittings quickly and efficiently.

## After sales service

### **Personal consultation**

We provide personal after-sale support. Your contact at Blum will be happy to answer any questions you might have about our products and services.



# moving ideas

We believe that ideas can move the world. We offer innovative fittings, inspiring furniture concepts and appropriate services so that you can turn your creative ideas into reality. We are driven by your needs, international trends and our shared vision of a better quality of living. Let us work together to create moving ideas.



## Quality of living

We would like you to enjoy greater convenience and functionality when using furniture.



## Product range

Everything from a single source: our wide range of products allows you to keep up with today's and tomorrow's trends.



## Inspiration

We monitor global trends and strive to create the solutions of tomorrow. We like to share our insights with you.



## Innovation

We stay in motion. Curiosity and pioneering spirit drive us to develop new products and services for you.



## Services

We support your daily operations with customised services tailored to your processes.



## Quality

We continuously strive to improve our products, services and ourselves.



## Trust

We take responsibility for partnerships, our employees, society and the environment.

Julius Blum started our journey in 1952 with horseshoe studs. Today we supply innovative fittings to customers in over 120 countries.

Julius Blum GmbH  
Furniture Fittings Mfg.  
6973 Höchst, Austria  
Tel.: +43 5578 705-0  
Fax: +43 5578 705-44  
E-mail: [info@blum.com](mailto:info@blum.com)  
[www.blum.com](http://www.blum.com)

Our sites in Austria, Poland and China are certified to the international standards mentioned below.  
Our site in the USA is certified to ISO 9001.  
Our site in Brazil is certified to ISO 9001, ISO 14001 and ISO 45001.



All content is copyrighted by Blum.  
Subject to technical modifications and changes to the range without notice.  
IDNR: 609.708.0 · EP-392/2 EN-AL/02.23

Look for our  
FSC™-certified  
products