



Exterior form, interior function:
Fitting solutions from Blum



ALUMIN

Content

Products	Living environments	DYNAMIC SPACE	About Blum	Services
6 Lift systems	40 Kitchen	52 Ideas from Blum for practical kitchens	58 Quality of motion is quality of life	64 Services
10 Hinge systems	44 Living room	54 Workflow	60 Design	66 E-SERVICES
14 BOX systems	46 Bedroom	56 Space	62 Quality and innovations	67 Contact
24 Runner systems	48 Bathroom	57 Motion		
32 Motion technologies	50 Office, shop and hall			





All furniture has two sides

Form

Furniture should not only be pleasing to the eye, it should also relate to a personal style. In addition to this, the design should take into consideration individual desires and current furniture trends. Fitting systems from Blum play a hidden role, our products work within the furniture interior to ensure your design ideas become a reality.



Function

Furniture also has to be functional. The overall design needs to take into consideration ergonomic work flows, ease of access and provide enough storage space to accommodate the users' needs.



Lift systems

Lift systems are an ideal ergonomic solution for wall units. Fronts open upwards to provide unhindered access to the cabinet interior.

The AVENTOS lift system is not only easy to use, it is also simple to install. Even heavy frontals open and close silently and effortlessly thanks to the integrated BLUMOTION dampening system.

AVENTOS in combination with SERVO-DRIVE can be used to create handle less designs that are a perfect balance between beauty and efficiency.

► More online: www.blum.com/aventos

Form

8



reddot design award
winner 2008

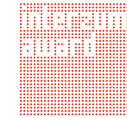

interzum award:
intelligent
material & design
2007



DESIGNPREIS
2009
NOMINIERT

With AVENTOS, you can implement solutions with a large-area gap design as well as a horizontal gap.

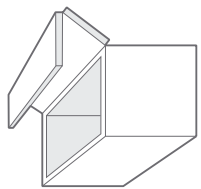

AVENTOS HF

Bi-fold lift system: Two-part front folds up

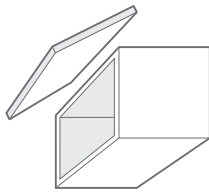

AVENTOS HS

Up & over lift system:
Single front swings up over the cabinet

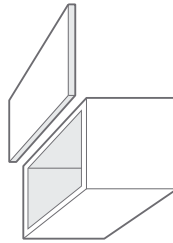

AVENTOS HL

Lift up: Single front lifts up parallel

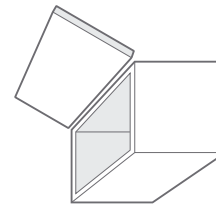

AVENTOS HK

Stay lift: Single front swings up

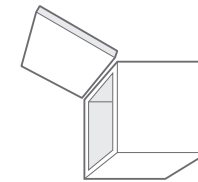

AVENTOS HK-S

Special small stay lift:
Single front swings up

Form

- Widths up to 1.800 mm and heights up to 1.040 mm are possible
- Extra wide elements are possible by combining several AVENTOS fittings
- Large-area fronts with or without a gap in the middle
- AVENTOS cover caps are available in white, grey or nickel plated





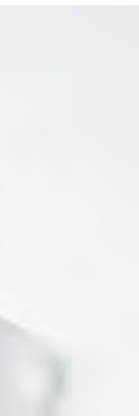
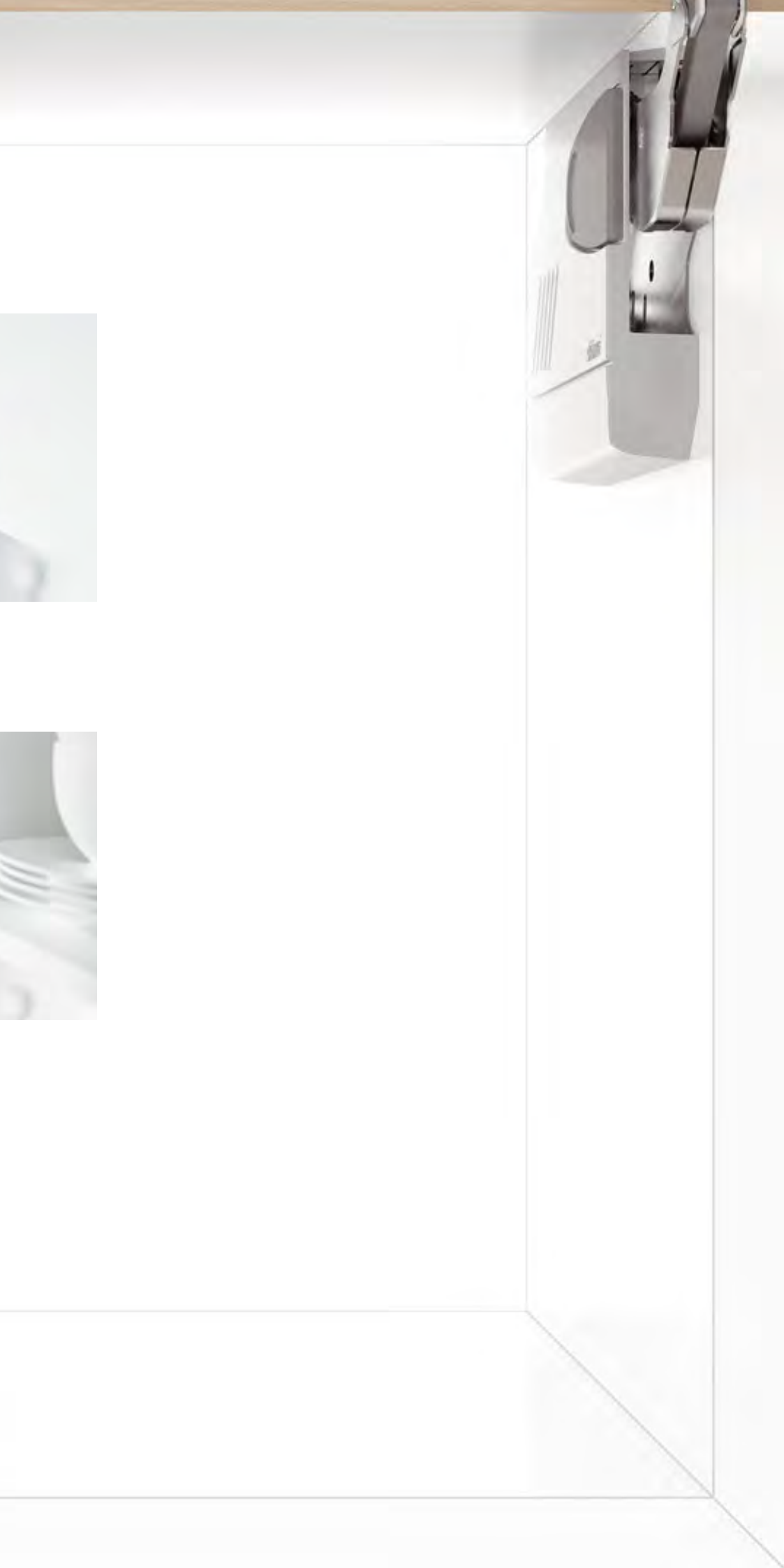



Hinge systems

CLIP top hinges are available for many different opening angles and applications.

They can be used with different door heights, thicknesses and materials as well as with glass and mirror doors. The easy 3-dimensional hinge setting feature makes it easy to get a uniform and precise gap design. And thanks to cover caps, adjustment and fixing screws are concealed.

Doors close silently and effortlessly with BLUMOTION dampening. This technology is now integrated into the CLIP top BLUMOTION hinge and is invisible to the furniture user.

► More online: www.blum.com/cliptop



Complex technology concentrated into the smallest space: Our BLUMOTION dampening is integrated into the hinge boss and invisible to the furniture user.

Individual design options for the cover cap on the hinge arm

Form

- Special hinges for glass, aluminium frame doors and many other special applications providing design freedom
- Easy adjustment option for a harmonious gap design
- Hinges for furniture with and without handles
- Hinges blend harmoniously and inconspicuously into the furniture interior





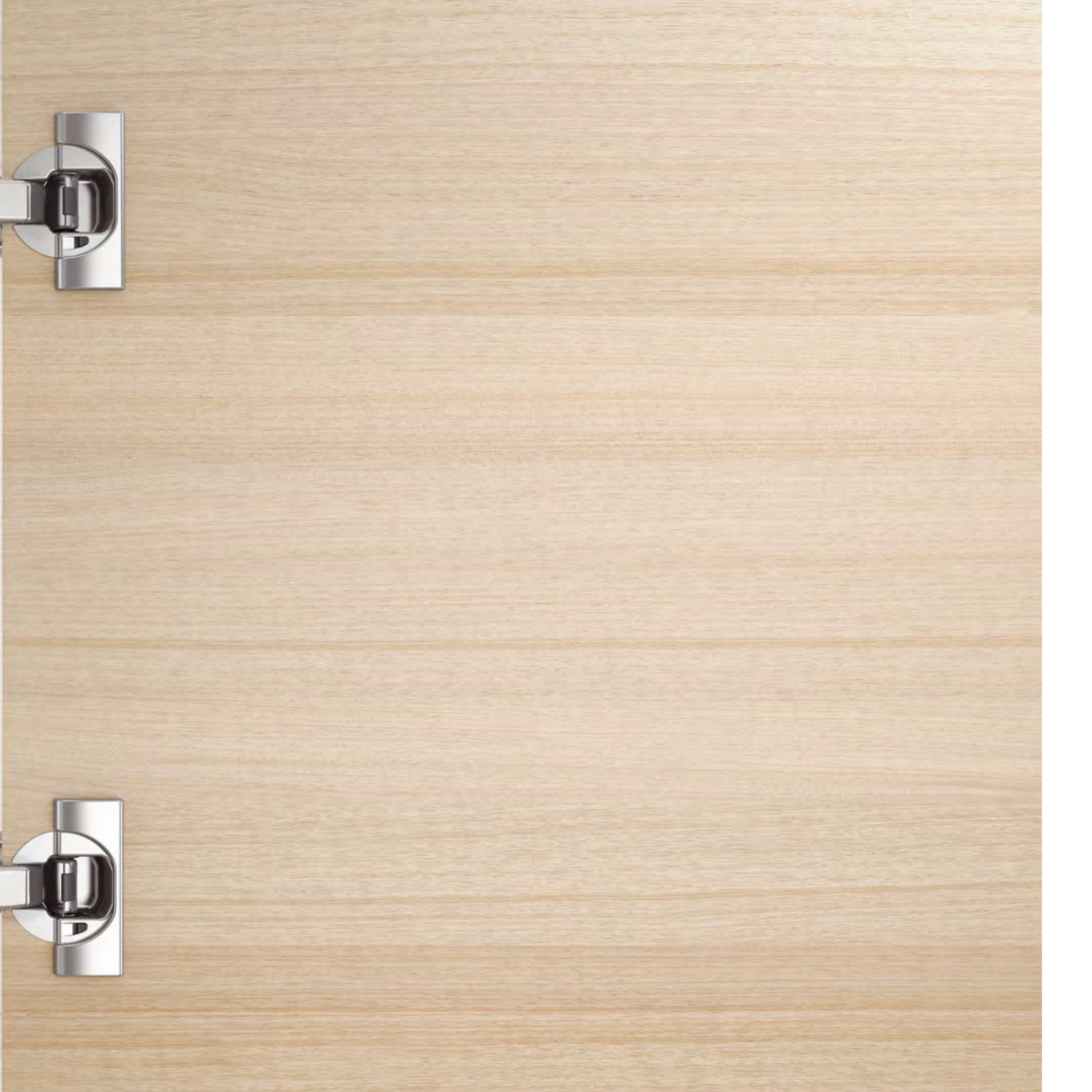

IS DIFFERENT, ALWAYS UNIQUE. ALWAYS DIFFERENT, ALWAYS UNIQUE. ALW
E. ALWAYS DIFFERENT, ALWAYS UNIQUE. ALWAYS DIFFERENT, ALWAYS UNIC
S UNIQUE. **ALWAYS DIFFERENT, ALWAYS UNIQUE.** ALWAYS DIFFERENT, ALW
T, ALWAYS UNIQUE. ALWAYS DIFFERENT, ALWAYS UNIQUE. ALWAYS DIFFERE
FFERENT, ALWAYS UNIQUE. ALWAYS DIFFERENT, ALWAYS UNIQUE. ALWAYS
LWAYS DIFFERENT, ALWAYS UNIQUE. ALWAYS DIFFERENT, ALWAYS UNIQ
NIOIIF. ΔI WAYS DIFFFRFNT ΔI WAYS IINIOIIF. ΔI WAYS DIFFFRFNT ΔI WAYS



blum

blum

BOX systems

Whether in the kitchen, living room, bathroom or office: drawers and pull-outs are a great way to provide an optimal overview and easy access to stored items.

The TANDEMBOX box system offers three different programme lines to fulfil individual customer wishes. The TANDEM smooth running action ensures high quality of motion and the integrated BLUMOTION dampening provides silent and effortless closing action. The SERVO-DRIVE electrical opening support system or the TIP-ON mechanical support system can be used for a handle-less design.

The ORGA-LINE inner dividing system provides extra overview and organisation in the drawer. This system is customised to the design of the three TANDEMBOX lines.



Good running action and high carrying capacity is required in furniture in all living areas.

Form

- Wide range of design options from the three TANDEMBOX programme lines: different colours, materials and profile shapes
- Extra wide drawers and pull-outs are possible Handleless furniture design is possible
- Easy front adjustment for a precise gap design and clear lines

Function

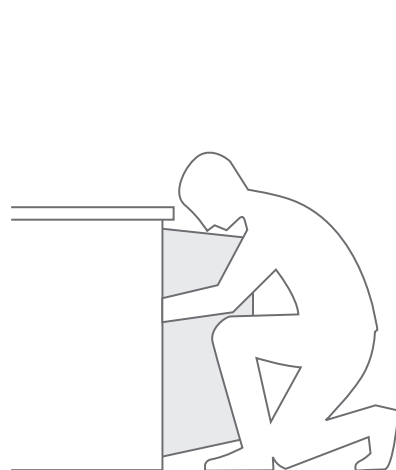
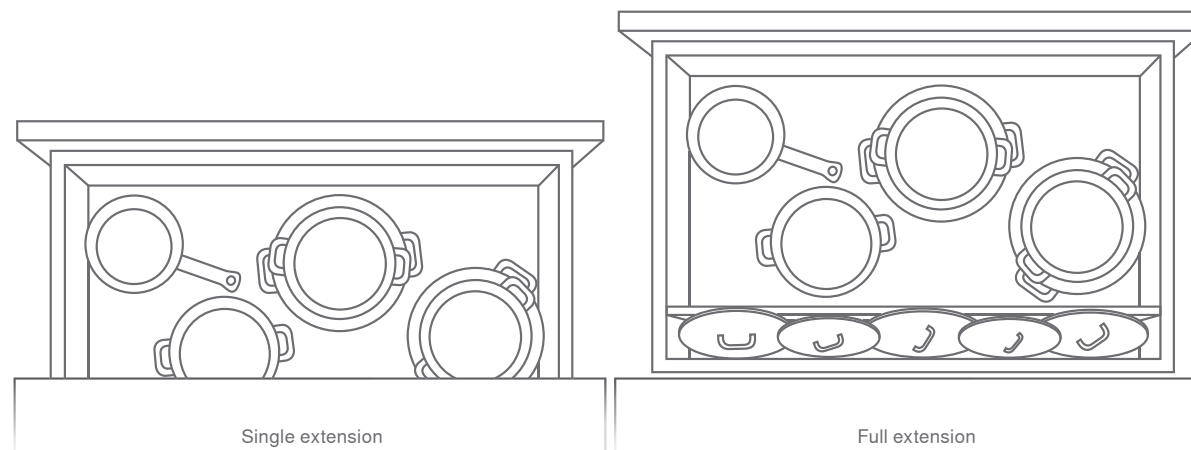

Shelves should be avoided in the base cabinet.

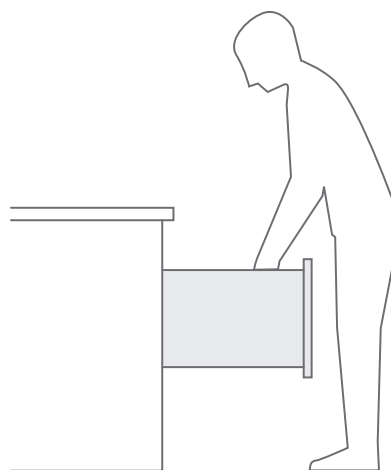

Box systems in the base cabinet ensure a good view and easy access.

Function

- The box system is versatile and well-suited for all living areas. As a high fronted pull-out, inner pull-out, drawer, inner drawer or as the SPACE CORNER corner cabinet solution
- Full extensions provide a good view and easy access even into the farthest corner
- The ORGA-LINE inner dividing system provides numerous application options
- Wide and heavily-loaded pull-outs are easy to operate
- Easy opening of handle-less furniture from an opening support system



The ORGA-LINE inner dividing system provides organisation



VICHY

HOTEL
WELCOME

HOTEL

Lalorri

HOTEL



reddot design award
winner 2007



interzum award:
intelligent
material & design
2007



product
design
award

2007 ■



DESIGNPREIS
2008

NOMINEE

TANDEMBOX intivo Balance between beauty and flexibility

The TANDEMBOX intivo programme can fulfil individual design requirements. TANDEMBOX intivo combined with the drawer side add-on BOXCAP creates a timeless, simple and uniform appearance.

Alternatively combine TANDEMBOX intivo with BOXCOVER and a design element to experience infinite possibilities with materials such as glass, timber or leather.

► More online: <http://myintivo.blum.com>



Individual design with your choice of design
elements attached to the side of BOXCOVER



Uniform design with BOXCAP, a cap on the drawer
side material





TANDEMBOX antaro
When a minimalist design is required

Less is often more – This is a job for TANDEMBOX antaro. All parts have a uniform colour: from the drawer, inner drawer, high fronted pull-out to the inner pull-out. With the square gallery, cabinet solutions can have a minimalist design even behind the front.



TANDEMBOX antaro is available in: Silk white



Terra black



Stainless steel



↑ blum

TANDEMBOX plus
As versatile as life itself

TANDEMBOX plus gives you wide-ranging design freedom. There are drawer sides in different heights. These can be combined with closed sides or gallery solutions, providing a wide range of applications. This programme line is characterised by the round gallery and uniform, grey nylon parts.

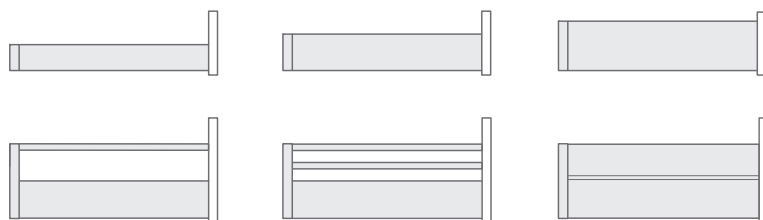

Whether it's a simple gallery, double gallery or closed container with BOXSIDE: TANDEMBOX plus makes many dreams come true.



Runner systems

Wooden drawers made by a tradesman or via industrial manufacturing, narrow, wide, low, high or square: Runner systems from Blum will win you over with their smooth running action even when heavily-loaded.

For a handle-less front design, an optional electrical or mechanical opening support system can be used. Thanks to the integrated BLUMOTION dampening, closing is silent and effortless. The ORGA-LINE inner dividing system provides organisation in the drawer.



A concealed Blum runner system provides smooth running action.

Form

- Runners are not visible to the furniture user
- Wide range of application options, e.g. pull-out surrounds, small drawers or extra wide pull-outs
- Precise gap design thanks to easy front adjustment
- Handle-design possible

Function

27



Full extensions provide a complete view and unhindered access even into the farthest corner.

Function

- Smooth and stable running action even when fully loaded
- Low sag values even for heavy pull-outs
- Silent and effortless closing action thanks to BLUMOTION
- The ORGA-LINE inner dividing system provides numerous application options
- Easy opening of handle-less fronts via an opening support system

The new runner system MOVENTO
The evolution of perfecting motion

The MOVENTO runner system takes the proven smooth running action of Blum runners to the next level:
The synchronised smooth running action provides high quality of motion.
And this for all applications: from drawers and inner drawers to high fronted pull-outs and inner pull-outs.

MOVENTO will be available in Central Europe starting in fall 2011

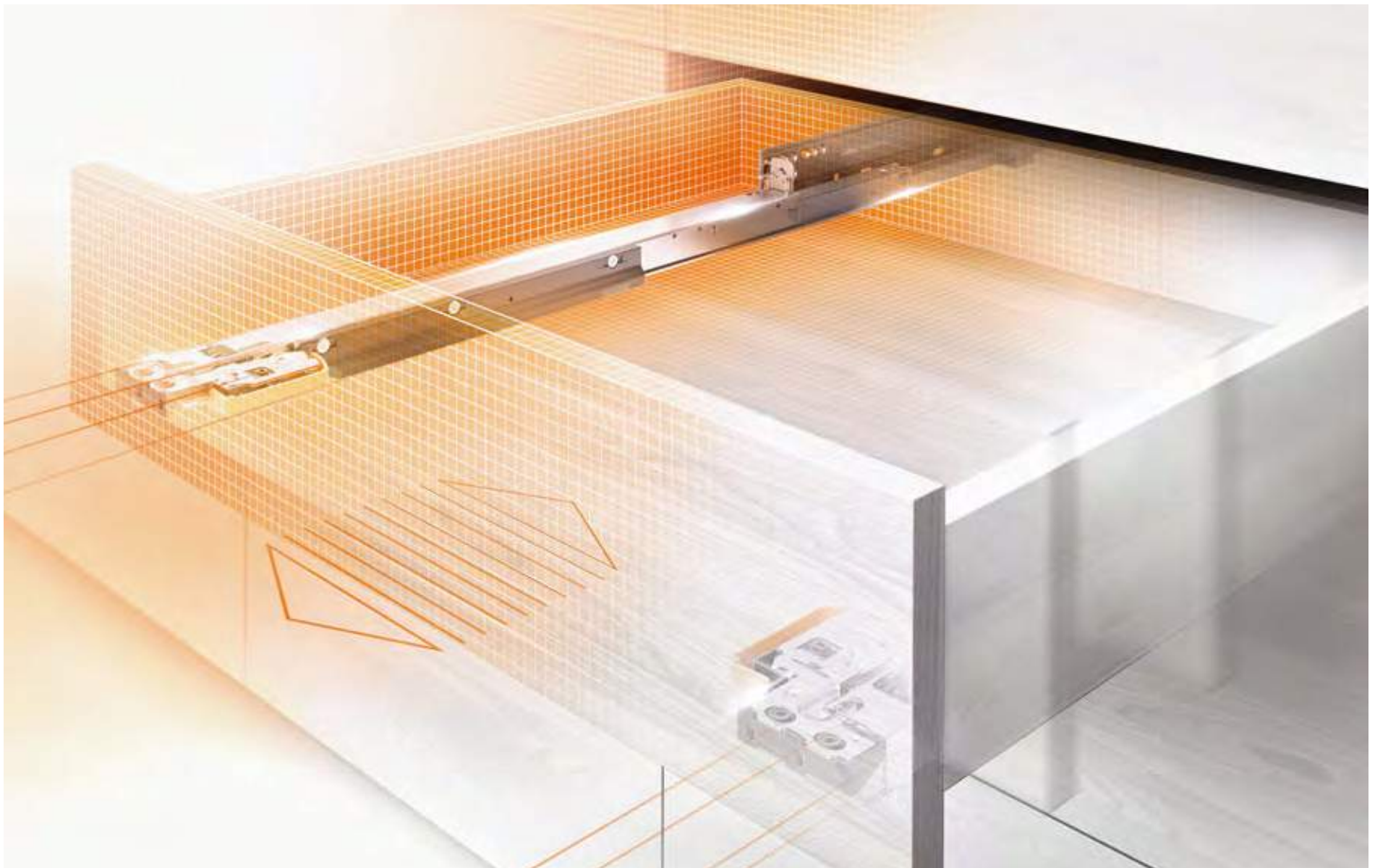

The synchronised runner system MOVENTO provides stable and smooth running action.



Precise gap design via 4-dimensional adjustment option



With MOVENTO, you can easily implement a handle-less design.

TANDEM**Proven drawers and pull-outs made from wood**

TANDEM is the proven runner system from Blum for wooden drawers and pull-outs. It provides smooth running action for both single and full extensions.



Thanks to optimised sag values, even extra wide and large pull-out elements can be realised near to the floor.



An optimal side stabilisation provides secure and stable parallel running for extra wide pull-out elements.



Proven Blum technology that is responsible for smooth running action: the roller carriage with low-friction, cylindrical nylon roller runners and dampened rail transitions for noise reduction.



Motion technologies

Fitting solutions from Blum make furniture easier to operate and provide a higher level of practicality and comfort. We strive to ensure that all Blum lift, hinge, BOX and runner systems fulfil these requirements. In order to reach this goal, we have developed many different motion technologies. They make furniture not only practical, but also offer a number of new design options.

SERVO-DRIVE

Ideal for handle-less furniture. Comfortable for furniture with handles.

Handle-less fronts are a major design trend; using the SERVO-DRIVE electrical opening support system, handle-less furniture can be opened easily. A light touch is enough – and lift systems, drawers and pull-outs open automatically with electrical support. This is especially practical for the waste bin pull-out. Because it can be opened when your hands are full, e.g. by pressing with your knee.

AVENTOS lift systems that are equipped with SERVO-DRIVE can also be re-closed electrically.

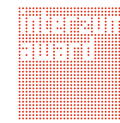

interzum award:
intelligent
material & design
2007



reddot design award
winner 2007



DESIGNPREIS
2008

NOMINEE





reddot design award
winner 2009

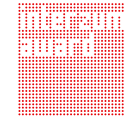

interzum award:
intelligent
material & design
2009



Designpreis
Deutschland
2010

NOMINEE



- Uniform technology, i.e. one system for all applications in wall and base cabinets.
- Easy to install
- Safe operation
- Low power consumption
- Manual operation possible at all times
- BLUMOTION dampening for silent and effortless closing action
- 5 year warranty

TIP-ON**Mechanically-supported opening**

Whether it's stay lifts, doors, drawers, or pull-outs: with TIP-ON, the mechanical opening support system, handle-less furniture can be used throughout the entire living area. TIP-ON cannot be combined with BLUMOTION dampening. Furniture is closed with a soft push or light press on the front.



BLUMOTION**Silent and effortless closing action**

With BLUMOTION, furniture closes silently and effortlessly – regardless of the force used or the weight of the pull-out or front. This function is integrated for lift systems, hinges, BOX and runner systems.

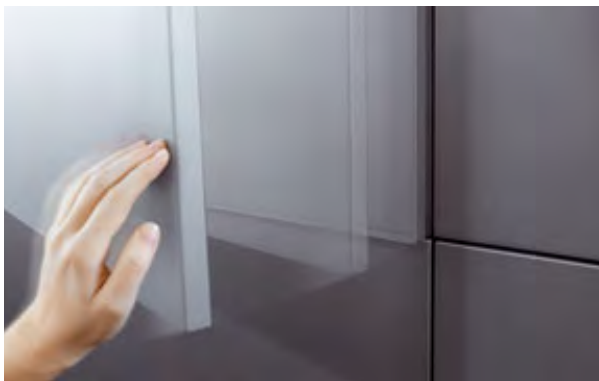

Our SERVO-DRIVE and TIP-ON opening support systems as well as BLUMOTION are available for these systems.

	BLUMOTION	SERVO-DRIVE	TIP-ON ¹
Lift systems	■	■	■ ²
Hinge systems	■		■
BOX systems	■	■	■
Runner systems	■	■	■

1. Cannot be combined with BLUMOTION

2. Only available for AVENTOS-HK



Living environments

Every living area has different requirements when it comes to furniture form and function.

With our extensive programme, we offer a number of solutions for any domestic or commercial space, whether it's the kitchen, bedroom, living room, bathroom, hall or shop.

AVENTOS HF – The fitting for bi-fold lift systems



Kitchens

41

The melding of living and eating areas is the trend. That's why kitchen design is becoming more and more important. However, the functional side of the kitchen should also not be neglected. Blum can support this with numerous practical solutions.



ORGA-LINE containers for cutlery



Blum sink pull-out



Pull-out with ORGA-LINE spice holder

Kitchen furniture sees regular intensive use over the years. High quality fitting systems play an important role in meeting the demands of everyday kitchen use for the lifetime of the furniture.



TANDEMBOX intivo with ORGA-LINE for bottles and cutting boards



ORGA-LINE plate holder



ORGA-LINE for pots and lids



ORGA-LINE foil/film dispenser

AVENTOS HL in the living room



Living room

45

Living room furniture should be well designed and practical. Beautiful designs need to allow for convenient storage space and easy access, as this is important in all living spaces.



Media solution and AVENTOS HL with SERVO-DRIVE

Bedroom

BLUMOTION dampening is especially nice in the bedroom. It provides silent and effortless closing action, ensuring a pleasant rest. High stability and good runner action for pull-outs provide additional comfort for furniture use.



Bed side cabinets with a TANDEM runner and integrated BLUMOTION



TANDEMBOX intivo with an individual design element





TANDEMBOX antaro and CRISTALLO hinges for mirror or glass doors

Bathroom

49

Furniture and their fittings come under special stresses from the high humidity in the bathroom. The zinc plated runners and nylon roller carriages offer the best protection against corrosion. The bathroom also requires furniture solutions that ensure optimal use of storage space. The ability to use wide drawers with short nominal lengths is a real advantage here. BLUMOTION also provides silent and effortless closing action in the bathroom.





Office, shop and hall

51

The right presentation also requires the right frame. High quality fittings system are part of this.

Sunglasses, keys, jackets or shoes – hall furniture needs to be able to store all kinds of different things.

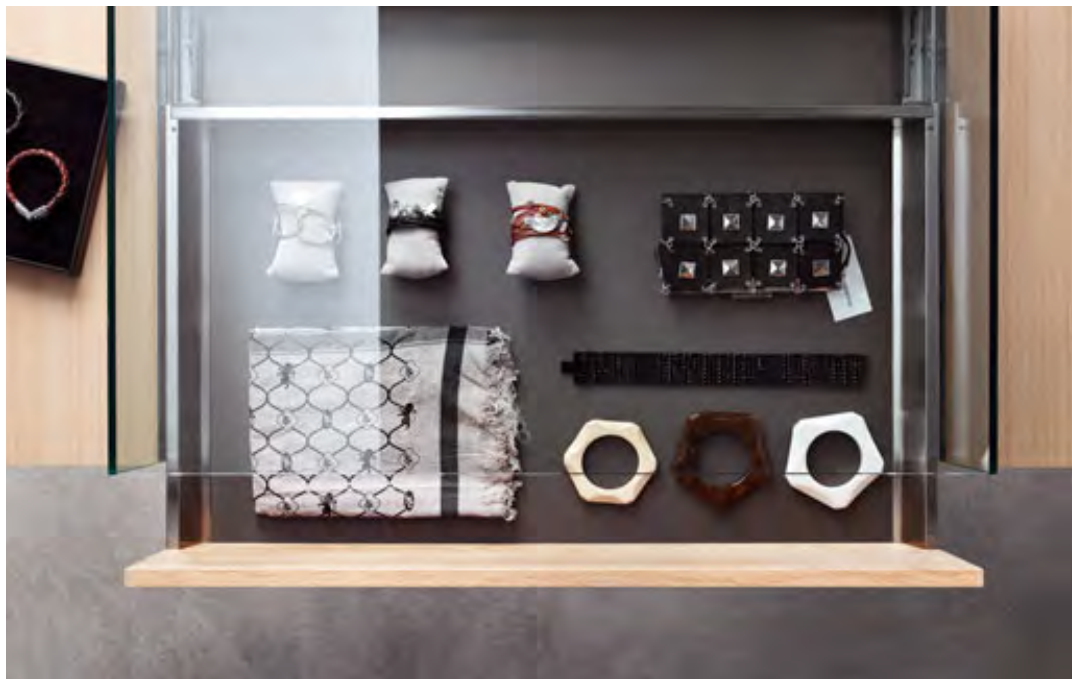

Counter solution for presenting and storing goods with TANDEMBOX intivo



Wardrobe cabinet with drawers and pull-outs



Ideas from Blum for practical kitchens

For many years, we have been researching the requirements of kitchen users. The knowledge from this then flows back into the development of our products, which makes the opening and closing of furniture simple and easy. Ultimately, furniture should be both beautiful as well as functional.



Ideas from Blum
for practical kitchens

Features of a practical kitchen

Workflow

Storage, preparation, replenishment are just a few of the many activities that take place in a kitchen. To avoid unnecessary paths, we recommend arranging the cabinets according to typical work flows in the kitchen. This sets up work areas or zones where items are stored in the zone in which they are actually used. High quality cabinet equipment and inner dividing systems then support easy access.



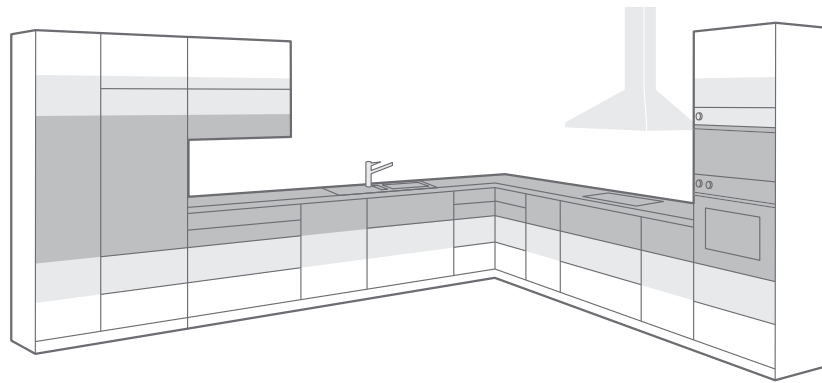

Things that are used most frequently should be quickly and easily accessible, ideally at mid-height. Things that are used less frequently should be stored at the top or at the bottom.

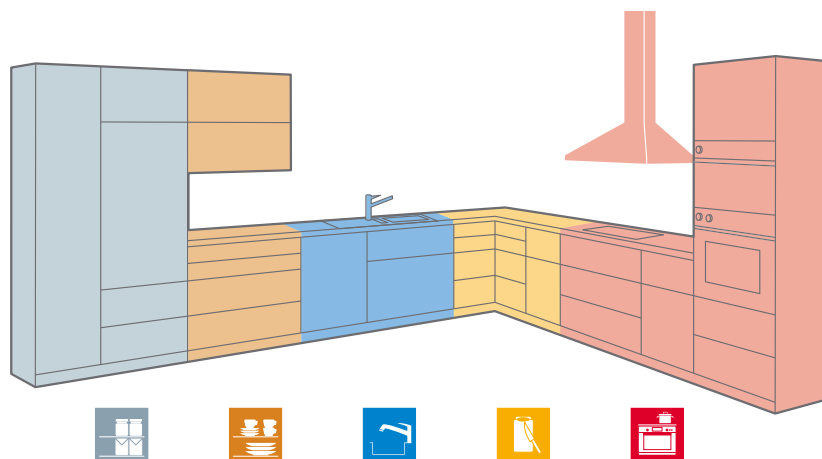

Planning in five kitchen zones reduces work paths and enables more fluid work flows.

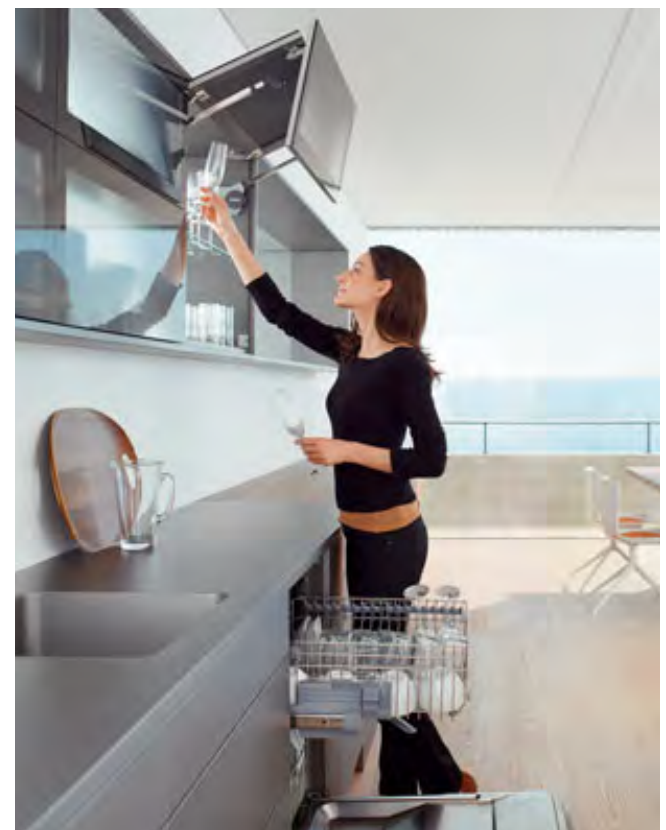

Lift systems open upwards, this means that they are not in the way of the user and enable easy access.

Motion

Over its lifetime kitchen furniture sees regular intensive use. That's why ease-of-use is especially important. Blum has the ideal solution: whether its easy opening with the SERVO-DRIVE electrical opening support system, the smooth running action of TANDEM for pull-outs or the silent and effortless closing action thanks to BLUMOTION dampening.





Quality of motion is quality of life

When developing our fitting solutions, we focus on the furniture user. Their requirements inspire us. This results in products that make the opening and closing of furniture an experience.





That's why **Perfecting motion** is our motto.



Abtumi

Innovations

Staying true to **Perfecting motion**, we are always striving to optimise our existing fittings and always looking for innovative ideas for new products. That's why many Blum solutions have become milestones in furniture manufacturing.

<p>1964</p>  <p>Production start</p> <p>With the introduction of chip-board in furniture manufacturing, Blum starts production on concealed furniture hinges.</p>	<p>1966</p>  <p>Roller runner</p> <p>The roller runner is introduced.</p>	<p>1985</p>  <p>CLIP</p> <p>The CLIP hinge system for tool-free mounting is introduced.</p>	<p>1990</p>  <p>METABOX-TANDEM</p> <p>The concealed drawer system with smooth running action and BLUMATIC self closing feature is introduced for the first time by brand name kitchen manufacturers.</p>	<p>1996</p>  <p>Full extension</p> <p>The full extension for BOX systems enhances the comfort in the kitchen.</p>
--	---	--	---	--

Demand for quality

Kitchens often last for 20 years or more. Lift systems, doors and pull-outs are opened and closed many times during this time. For us it is important that our products meet the requirements of such a long lifespan. That's why we demand such high quality for our fittings and put them through intensive testing in our test labs.

However, we aren't just concerned with product quality. A high level of service quality is also important to us when working with our customers, partners and vendors.

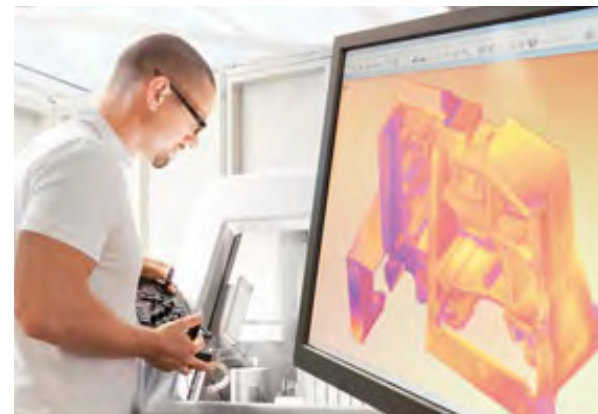

2001**BLUMOTION**

BLUMOTION provides silent and effortless closing action.

2005**AVENTOS**

AVENTOS lift systems are presented for the first time.

2007**SERVO-DRIVE**

SERVO-DRIVE receives numerous awards for its wonderful design and excellent function.

2009**CLIP top BLUMOTION**

with an integrated BLUMOTION function debuts on the market.

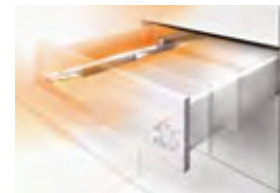
2011**MOVENTO**

The runner system with synchronised smooth running action for even better runner action.



International presence: We are present in many countries all over the world with our subsidiaries and sales agencies.

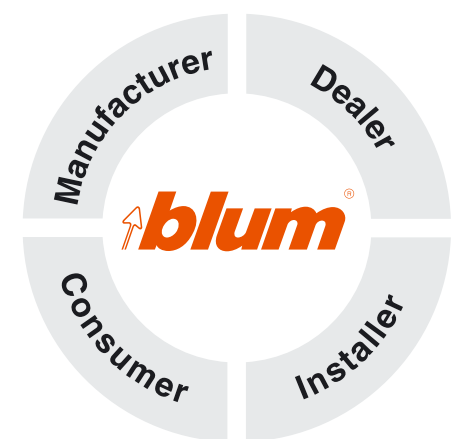

Our efforts: Everyone who deals with Blum products should profit. We call this global customer benefits. To meet our goal, we maintain a dialogue with our customers around the world and take their feedback.



Services for designers and architects

We take all of your questions regarding fittings systems very seriously: we provide a wide range of services.



E-SERVICES

Everything online. Easily accessible.

We offer a wide range of planning services. We provide useful information and advertising material – always up-to-date and easily downloaded online.

More online:  <http://e-services.blum.com>

E-Service POIS

- Detailed product information and item descriptions
- Download options for product pictures/graphics and CAD data

E-Service MAIS

- Tools for creating marketing documents and presentations

Information at www.blum.com

- At the download center for documents, e.g. advertising information, catalogues, product brochures



For designers and architects, we provide numerous advertising documents and texts. All advertising texts are also available in digital form for easier access. They can be downloaded from our homepage at www.blum.com.



Blum Austria

Seven of our plants are located in Vorarlberg in Western Austria. We manufacture lift, hinge, BOX and runner systems for the global market. Our fittings provide comfort of motion in furniture and make it easier to implement numerous design ideas.



Your contact partner

Good service always begins with good advice.
We are there for you.





The Blum logo consists of a stylized orange arrow pointing upwards and to the right, followed by the word 'blum' in a bold, lowercase, orange sans-serif font. A registered trademark symbol (®) is located at the top right of the word.

Julius Blum GmbH
Furniture Fittings Mfg.
6973 Höchst, Austria
Tel.: +43 5578 705-0
Fax: +43 5578 705-44
E-mail: info@blum.com
www.blum.com

All content is copyrighted by Blum.
Subject to technical modifications and changes to the range without notice.
Printed in Austria. IDNR: 902.932.7 · EP-181/1 EN-AL/04.11-1
LIGHTHOUSE.de