



METABOX with BLUMOTION

New variation on proven Technology

www.blum.com

 **blum**[®]

Motion is being optimised

 **blum**





**The METABOX programme.
A High quality programme with
minimum components.**

blum



**The silent and effortless closing of furniture –
This is becoming appreciated more and more by people in their homes.**

Now this BLUMOTION comfort is also available for METABOX. Thus you can offer your customers a high-quality and, at the same time, economical system with only a few components.



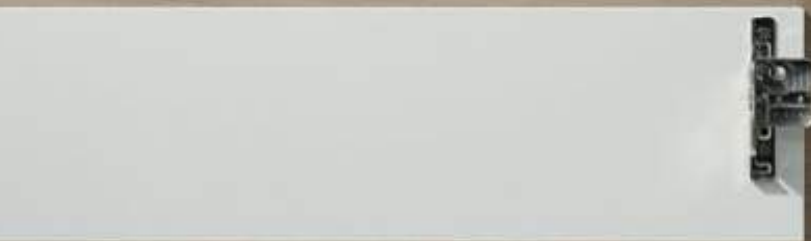
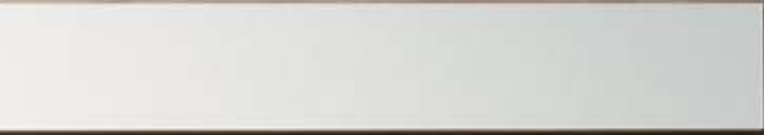

**BLUMOTION closing comfort.
BLUMOTION brings silent and
effortless closing action to
METABOX.**

blum



Now you can also use the tried and tested BLUMOTION function with METABOX: Ensuring that drawers and pull-outs always close silently and effortlessly – regardless of the closing force or the weight of storage items.

BLUMOTION for METABOX has been specially designed for single extensions with a total load of 25 kg – for smooth running and excellent closing action. Despite the high dampening power, pull-outs and drawers open very easily.

Especially practical and economical: You only need one BLUMOTION for most applications.



METABOX BLUMOTION.
A perfect team.

blum





BLUMOTION and the integrated BLUMATIC work as perfect partners. They ensure silent and effortless running action as well as a secure close. BLUMOTION is compatible with all METABOX single extensions for heights N, M, K, H up to a total load of 25 kg.

	BLUMOTION	Part No.
	BLUMOTION with latch in cream (CW), recommended for drawer sides in cream	Z70.0320
	BLUMOTION with latch in white (W), recommended for drawer sides in white	Z70.0320
	BLUMOTION with latch in white grey (WGR), recommended for drawer sides in white aluminium	Z70.0320
	The BLUMOTION housing is always white grey.	

**METABOX quality.
Everyday kitchen activities
define our demand for quality.**

↑blum®



Everyday kitchen activities define our demand for quality

METABOX with BLUMOTION



Opening and closing 100.000 times: This is only one of the many tests that METABOX and BLUMOTION must endure in our testing labs. In the end, our products must be ready for the varied demands required in the modern kitchen and provide joy for the lifetime of the furniture.



METABOX stands for excellent runner action and high stability – even under heavy loads. You can also see quality in the details: Each METABOX has an integral pull-out stop which is also used when a static position is required – e.g. when using a bread slicer.



**The METABOX runner.
Excellent runner action and
reliable stability.**

↑blum®



Excellent runner action and reliable stability

METABOX with BLUMOTION



Low-friction nylon rollers help to ensure this excellent runner action. METABOX has built in 2mm tolerance compensation for drawer assembly. This ensures that METABOX always runs easily and smoothly.

A selection of high-strength materials and precise assembly ensure the best stability values – all that and a max. dynamic carrying capacity of 25 kg.

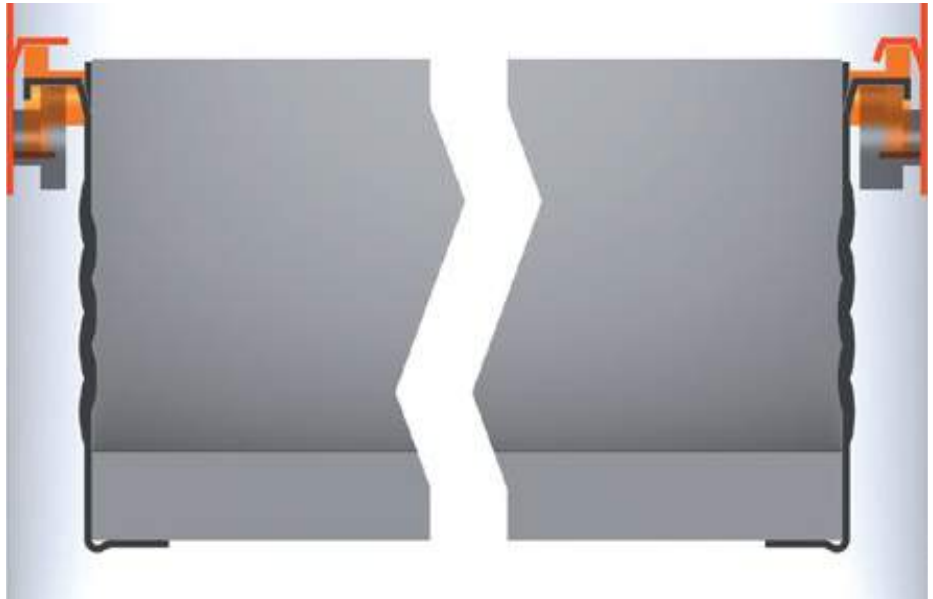

Tolerance compensation only takes place on the left cabinet side. On the right side, the drawer or pull-out is guided on the side in a stable manner.



METABOX drawers and pull-outs are very easy to insert and remove. This makes assembly easy and simplifies drawer cleaning.

**The METABOX design.
Many opportunities with
a universal design.**

↑blum®



Many opportunities with a universal design

METABOX with BLUMOTION



Although the METABOX programme only comprises a few components, it gives you so much freedom: Thanks to different cabinet widths, drawer side heights and lengths, you can implement various applications. When designing the high fronted pull-out, you can choose between a gallery or single walled BOXSIDE. Even the colour choices provide you – and your customers – with several options.



Drawer side height N (54 mm)



Drawer side height M (86 mm)



Drawer side height K (118 mm)



Drawer side height H (150 mm)



Drawer sides come standard in cream (RAL 9001); white and grey (RAL 9006) are available upon request.



METABOX is available for the following ...

- Drawer side heights: N (54 mm), M (86 mm), K (118 mm), H (150 mm)
- Nominal lengths: 270 to 550 mm

The METABOX drawer.
Great for use anywhere.

 **blum**



Great for use anywhere

METABOX with
BLUMOTION



Whether in the kitchen, living room or hall: METABOX is suitable for all living areas and has already proven itself in offices and showrooms. METABOX offers the right solution for any installation situation due to its flexibility in width, height and depth.



The METABOX high fronted pull-out. Offers storage space and high durability.

↑blum®



Offers storage space and high durability

METABOX with
BLUMOTION



Heavy storage items are accommodated by the METABOX high fronted pull-out – It is designed for a max. carrying capacity of 25 kg.

You can design the drawer to your own taste: With a single walled BOXSIDE, gallery or double gallery. And for organisation and overview, you can use ORGA-LINE longside and cross dividers.

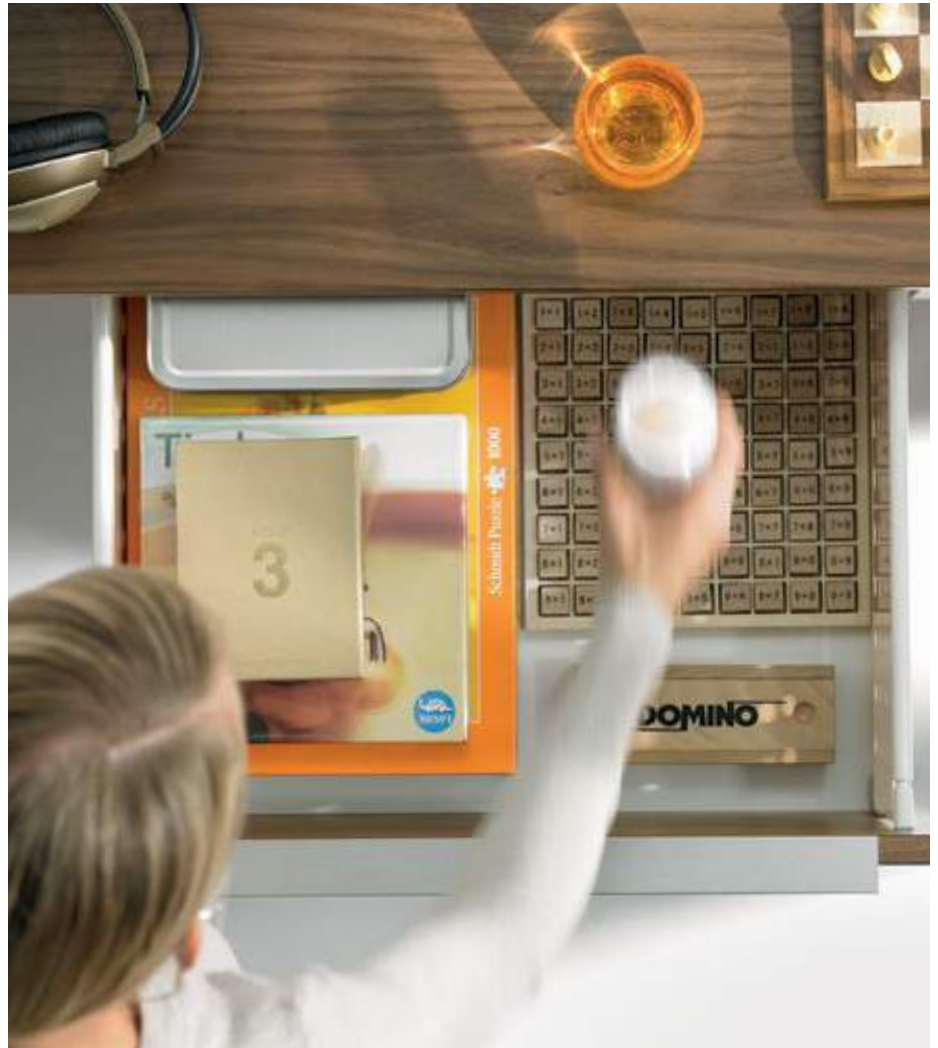

i

METABOX for high fronted pull-outs is available for the following ...

- Back heights: B (167 mm), C (207 mm), D (231 mm)
- Nominal lengths: 350 to 550 mm

The METABOX inner drawer.
For flexibility behind the
furniture front.

 **blum**



For flexibility behind the furniture front

METABOX with
BLUMOTION

 blum®

You can plan METABOX inner drawers using all drawer side heights providing customised solutions. Because METABOX is robust, the programme is also well-suited for use in showrooms.



i

METABOX for inner drawers is available for the following ...

- Drawer side heights: N (54 mm), M (86 mm), K (118 mm), H (150 mm)
- Nominal lengths: 270 to 550 mm

METABOX assembly.
A High quality programme which
is easily assembled.

blum

A High quality programme which is easily assembled.

**METABOX with
BLUMOTION**



The few components of the METABOX programme can be assembled in no time: You can use the classic screw-on assembly as well as the tool-free Blum CLIP and INSERTA assembly methods.

You only need to attach the BLUMOTION unit to the left cabinet side. The drillings for all parts use the 32 mm drilling system.

And the front can be adjusted in 3 dimensions to easily ensure a harmonious gap design.



One-sided assembly is enough: Only one BLUMOTION unit is required for most applications



Activating the BLUMOTION function: The latch on the base of the drawer.

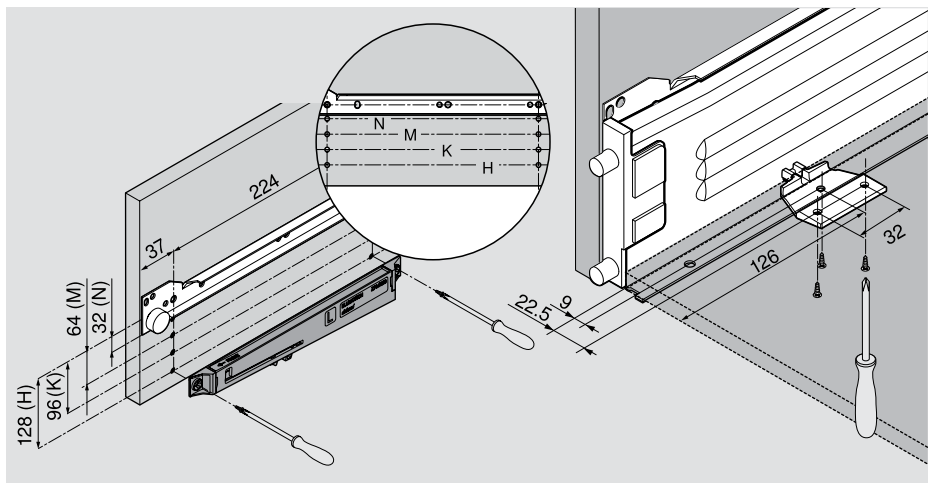

System 32: BLUMOTION unit assembly uses a 32 mm drilling system.



Side adjustment range: ± 1.5 mm



Height adjustment range: ± 1.8 mm



The high fronted pull-out has tool-free tilt adjustment via the gallery.

**METABOX accessories.
The right solution for all
situations.**

blum



The right solution for all situations.

**METABOX with
BLUMOTION**



Everything neatly arranged – This is provided by the longside and cross dividers of our ORGA-LINE inner dividing system (for METABOX high fronted pull-outs with BOXSIDE, single or double gallery)

Spacer	Spacing	Part No.
	4 mm	320M0048
	8 mm	320M0088
	8 mm with dowel Ø 5 mm	320M0188
Screw-on spacers bridge the door protrusion for inner drawers.		

POSISTOP	Front gap	Part No.
	1,5 mm	298.3210.01
	3 mm	298.3230.01
POSISTOP dampens the stop in runner systems and can also be used symmetrically.		

Whether in the kitchen, living rooms or office: You can offer your customers special solutions for different applications with these versatile accessories.



Child safety latch	295.5500
Whether it's medicine or cleaning materials – everything is stored safely with the child safety latch.	



METAFILE	ZRM.5500
Create organisation: The METAFILE file drawer for the METABOX high fronted pull-out.	



Pull-out stop	320M0009.01
Prevents accidental removal: The pull-out stop.	



Contoured profile	ZSD.1200S
The base profile forms a flexible lip between the base and drawer side. This makes cleaning much easier.	

The company Blum

Founded over 60 years ago by Julius Blum, Blum is a family-owned company that operates on an international scale. Its strategic business segments include lift, hinge and pull-out systems. All our product developments focus on perfecting motion.

www.blum.com

 **blum**[®]





Blum in Austria and around the world

The company has seven plants in Vorarlberg, Austria, additional production sites in Poland, the USA and Brazil and 29 subsidiaries/representative offices. Blum supplies more than 120 markets. The Blum Group employs 7.300 people in total, 5.500 of whom work in Vorarlberg.



Global customer benefits

“Whether manufacturer, distributor, fitter or kitchen user – everybody should personally enjoy the benefits of Blum products” – that is Blum’s philosophy on global customer benefits.



Innovations

To support customers with innovative fittings solutions and secure long-term success for the company, we need to consistently invest in research and development, in plants and facilities and in employee training. With more than 2.600 patents worldwide, Blum is one of Austria’s most innovative companies.



Quality

Blum’s comprehensive concept of quality does not only apply to products. Services and collaboration with customers and partners should also meet the same quality requirements.



Environment

At Blum, we believe that responsible ecological behaviour has long-term economic benefits. The longevity of products is just one of many important aspects. Other important measures include the use of environmentally-friendly processes, the intelligent use of materials and prudent energy management.



DYNAMIC SPACE

Good workflows, optimum use of storage space and top quality motion are important features of a practical kitchen. Blum’s ideas for practical kitchens are designed to bring function, convenience and ergonomics to furniture interiors.



Julius Blum GmbH
Furniture Fittings Mfg.
6973 Höchst, Austria
Tel.: +43 5578 705-0
Fax: +43 5578 705-44
E-mail: info@blum.com
www.blum.com

